

# NAPOLEON®

BUILT-IN GRILLS

EXPERTS IN GAS & INFRARED GRILLING



[napoleongrills.com](http://napoleongrills.com)





## THE STORY

It all began in 1976 when a small steel fabrication business launched by Wolfgang Schroeter started manufacturing steel railings in Barrie, Ontario, Canada. At that time, no one could imagine the incredible future that lay ahead for Wolf Steel Ltd. and eventually Napoleon® Fireplaces and Napoleon® Grills. Since the first wood stove rolled off the production line over 38 years ago, Wolf Steel's commitment was to be distinctive and successful in everything they do. The original stove featured a solid cast iron two-door design and was produced in a one thousand square foot manufacturing facility. By 1981, the name "**Napoleon**" was born and with it, the first single glass door with Pyroceram high temperature ceramic glass – a first in the industry. This was the first of many milestones for Wolf Steel Ltd. and over the next few years, the demand for Napoleon's wood stoves grew beyond Ontario's borders to the rest of Canada, the United States, Europe and the United Kingdom. Napoleon® is an ISO9001 – 2008 registered company and operates with 1.4 million+ square feet of manufacturing space and over 1,000 employees. Napoleon® is North America's largest privately owned manufacturer of quality wood and gas fireplaces (inserts and stoves), gas and charcoal grills, outdoor living products and a complete line of heating and cooling equipment.



## CREATIVE SPIRIT, PERFORMANCE & QUALITY

A passionate dedication to grilling.

Napoleon®, a two generation family owned Canadian company, has been providing home products for over 38 years, committed to designing and manufacturing only the finest high efficiency grills, fireplaces and outdoor living products you can depend on.... Proudly backed by the President's Limited Lifetime Warranty and all grills in this brochure are proudly made in Canada at the factory in Barrie, Ontario.

Superior technology, rock solid performance, balanced design and unparalleled customer service are the hallmark of the Napoleon® name. Your Napoleon® grill is designed to excel, offering a cooking experience as gratifying as the wonderful meals you'll create with it.

In the pages ahead, you'll discover the beauty and simplicity of Napoleon® style - the ideal complement to your patio environment.

Wishing you many unforgettable meals - grilled to perfection.



We are proud to be recognized as one of Canada's Best Managed Companies and are dedicated to providing quality, home comfort products for over 38 years and counting.

# PRESTIGE PRO™

## BIPRO825RBI WITH REAR INFRARED BURNER, INFRARED SIZZLE ZONE™ BOTTOM BURNERS AND SMOKER TRAY

Up to 106,000 BTU's  
9 burners  
Cooking Area: 1245 in<sup>2</sup> (8140 cm<sup>2</sup>)  
Cart model available



Doors and drawers are optional. Island not included.

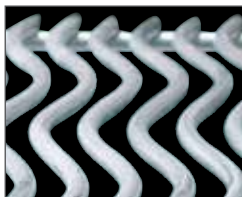

9.5 mm Stainless Steel WAVE™ Cooking Grids



Infrared SIZZLE ZONE™ Bottom Burners with Warming Tube Burner



Rear Infrared Rotisserie Burner



Integrated Wood Chip Smoker Tray



Proudly Made in Canada



### CLASSIC COWBOY STEAK WITH GRILLED MUSHROOMS, ONIONS, AND BLUE CHEESE

<b>Bone-in Cowboy / Rib Steaks</b> (2" to 3" thick - 24 oz / 680 g)	2		2
<b>Large Portobello Mushrooms</b> stems removed, soaked in warm water for 1 hour	4		4
<b>Medium White Onions</b> peeled and trimmed with root end attached	2		2
<b>Olive Oil</b>	1 tbsp		15 mL
<b>Steak Spice</b>	to taste		to taste
<b>Steak Sauce</b>	½ cup		125 mL
<b>Crumbled Blue Cheese</b>	1 cup		250 mL
<b>Seasoning Paste</b>			
<b>Olive Oil</b>	¼ cup		60 mL
<b>Steak Spice</b>	2 tbsp		30 mL
<b>Shiraz</b>	4 tbsp		60 mL
<b>Minced Garlic</b>	4 cloves		4 cloves
<b>Chopped Fresh Thyme</b>	1 tbsp		15 mL

### INFRARED TECHNOLOGY

The intense heat of Napoleon's infrared technology instantly locks in the juices for an amazing taste sensation! Over 11,000 flame ports produce up to 1800°F for optimum searing. See page 17 for more details.



# PRESTIGE PRO™

## BIPRO665RB WITH REAR INFRARED BURNER, AND INTEGRATED SMOKER TRAY

Up to 86,000 BTU's  
7 burners  
Cooking Area: 1000 in<sup>2</sup> (6510 cm<sup>2</sup>)  
Cart model available

**Serves:**   
**Prep Time:** 20 minutes  
**Grilling Time:** 45 minutes

1. In a small bowl, mix together olive oil, steak spice, Shiraz, garlic and thyme. Rub the steaks with the seasoning paste, pressing the seasoning into the meat to adhere. Cover and set aside until needed.
2. Drain portobello mushrooms from water and pat dry with paper toweling. Slice onions into 4 wedges through the root end. Season mushrooms and onion wedges with olive oil, and steak spice to taste.
3. Preheat grill to high heat.
4. Grill mushrooms and onions for 10 to 18 minutes, turning occasionally until lightly charred and tender. Set aside on the warming rack of the grill to keep warm.
5. Place steaks onto preheated grill and sear for 3 to 4 minutes per side. Reduce heat to medium and place steaks on the warming rack of the grill. Close lid and allow steaks to roast for an additional 10 to 15 minutes for medium-rare doneness, basting every few minutes with steak sauce.
6. Remove steaks from grill and allow to rest for 1 to 2 minutes.
7. Remove mushrooms and onions from grill and slice into 1" to 2" thick pieces.
8. Slice steaks into 1" thick slices across the grain and arrange on a platter. Top with the grilled onions and mushrooms and crumbled blue cheese. Serve immediately.
9. Try serving these succulent steaks with a glass of Shiraz.

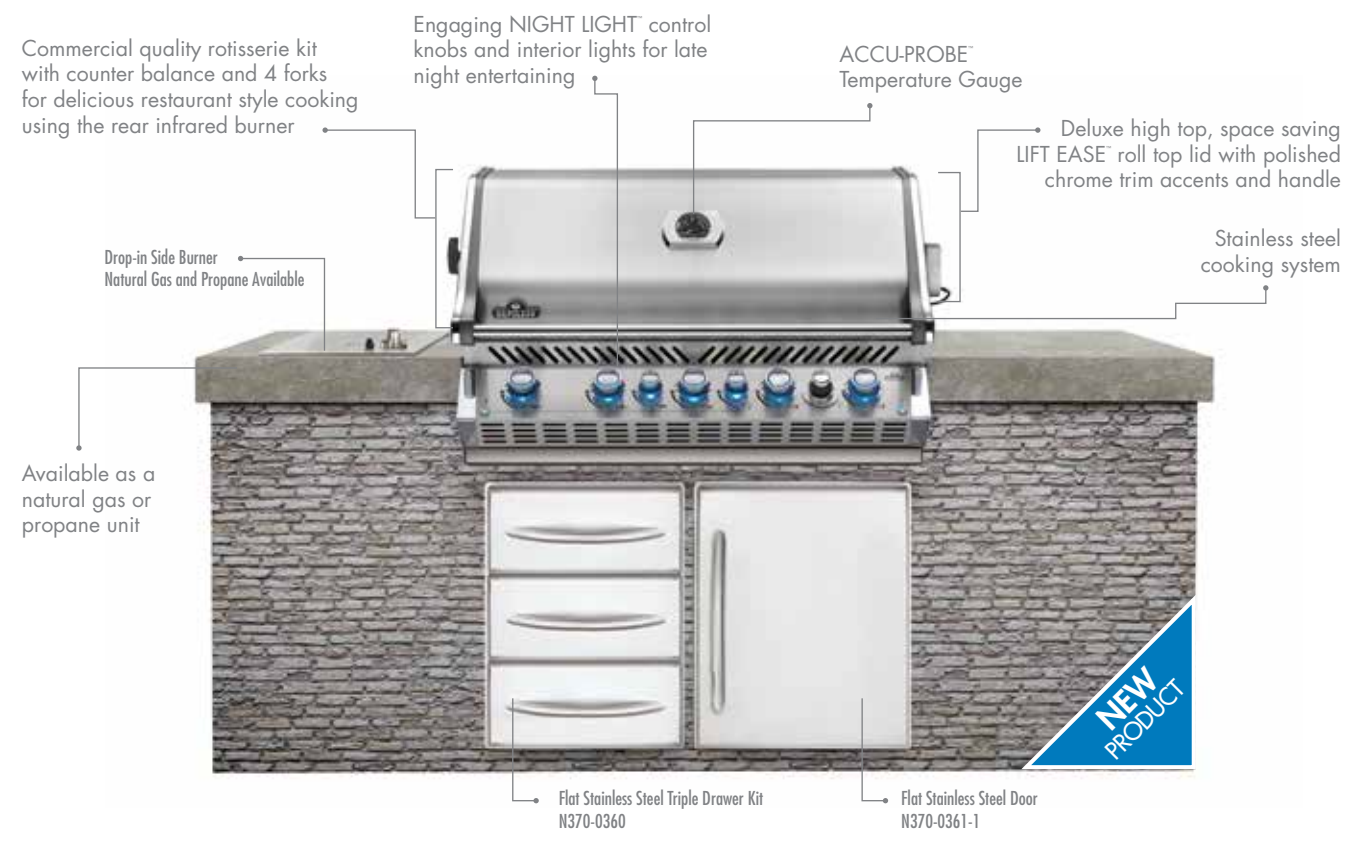

Doors and drawers are optional. Island not included.

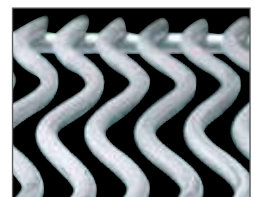

9.5 mm Stainless Steel WAVE Cooking Grids



NIGHT LIGHT Control Knobs



Rear Infrared Rotisserie Burner



Integrated Wood Chip Smoker Tray



 Proudly Made in Canada

### CHARCOAL FLAVOR FROM YOUR GAS GRILL

Napoleon's optional charcoal tray is designed to let you add the fun & flavor of charcoal any time, on your gas grill. Simply replace sear plates with the charcoal tray, add charcoal and light with your gas burner. For more details see page 16.



# PRESTIGE PRO™

## BIPRO500RB WITH REAR INFRARED BURNER

Up to 66,000 BTU's  
5 burners  
Cooking Area: 760 in<sup>2</sup> (4880 cm<sup>2</sup>)  
Cart model available

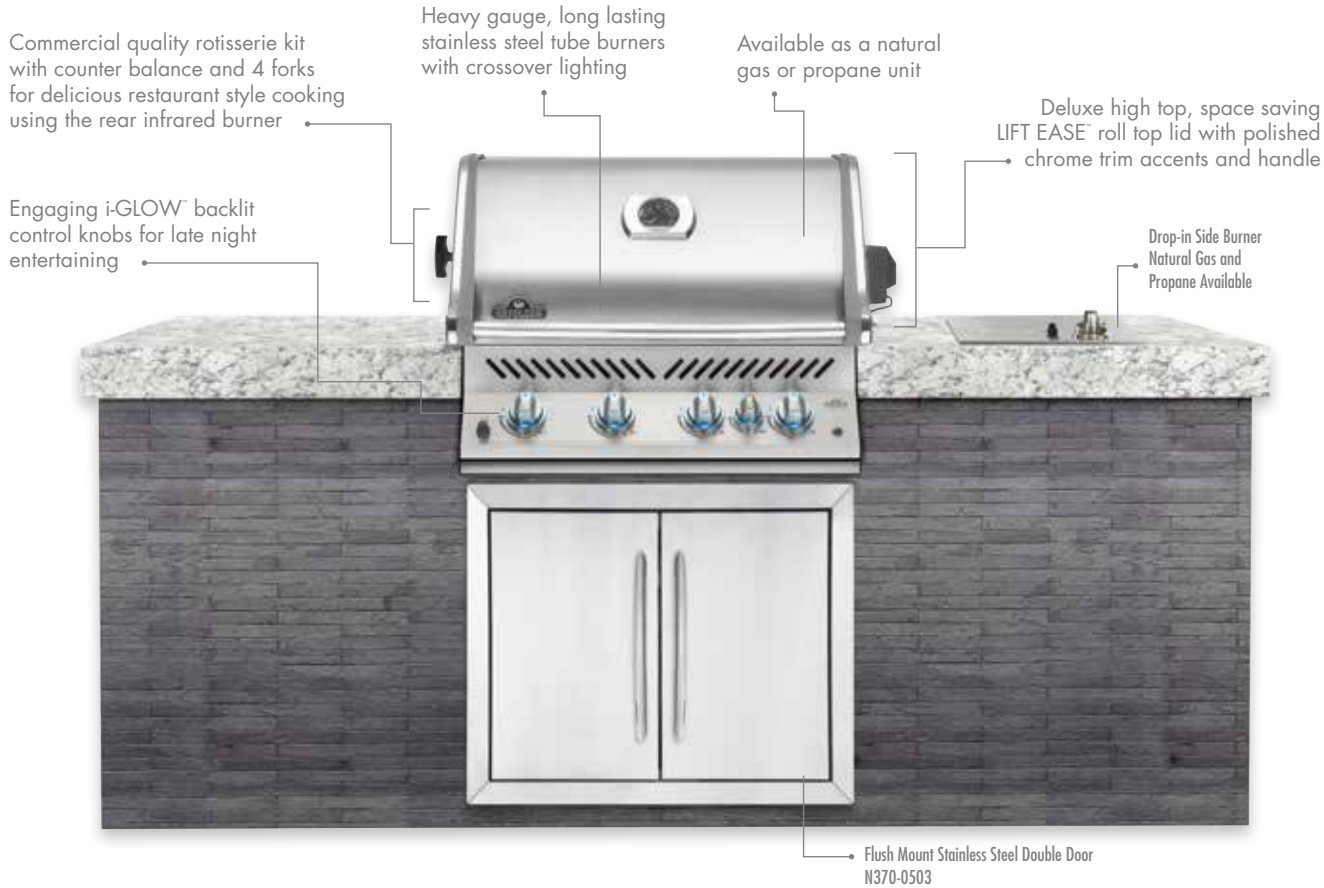

Doors and drawers are optional. Island not included.

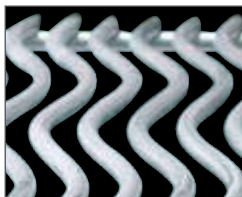

9.5 mm Stainless Steel WAVE™ Cooking Grids



Dual-Level, Stainless Steel Sear Plates



i-GLOW™ Backlit Control Knobs



Rear Infrared Rotisserie Burner



 Proudly Made in Canada

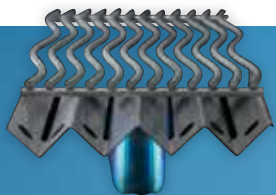

### HEAVY DUTY STAINLESS STEEL COOKING SYSTEM

The even, consistent heat from high and hot to low and slow. WAVE™ cooking grids for those trademark Napoleon™ sear lines, self cleaning sear plates for reduced flare-ups and durable burners for controlled, even heat.

## DOUBLE THICK PORK CHOPS WITH FIRE-ROASTED CORN SALSA

Napoleon® Marinade Injector	1		1
Boneless Pork Loin Chops about 2" to 3" thick (8 oz / 227 g)	4		4
Cajun Creole Spice	¼ cup		60 mL
Buffalo Injector Sauce	¾ cup		150 mL
Buffalo Injector Sauce	½ cup		60 mL
Balkan-Style Honey	½ cup		75 mL
<b>Fire-Roasted Corn Salsa</b>			
Cajun Creole Spice	to taste		
Fresh Corn husks and silk removed	2		2
Olive Oil	1 tbsp		15 mL
Medium Red Onion peeled and sliced into ¼" wide rings	1		1
Red Pepper stem and seeds removed	1		1
Jalapeño Pepper	1		1
Fresh Cilantro chopped	1 tbsp		15 mL
Olive Oil	¼ cup		60 mL
Lime juiced	1		1
Salt and Coarsely Ground Black Pepper	to taste		



# PRESTIGE®

## BIP500RB WITH REAR INFRARED BURNER

Up to 66,000 BTU's  
5 burners  
Cooking Area: 760 in<sup>2</sup> (4880 cm<sup>2</sup>)  
Cart model available

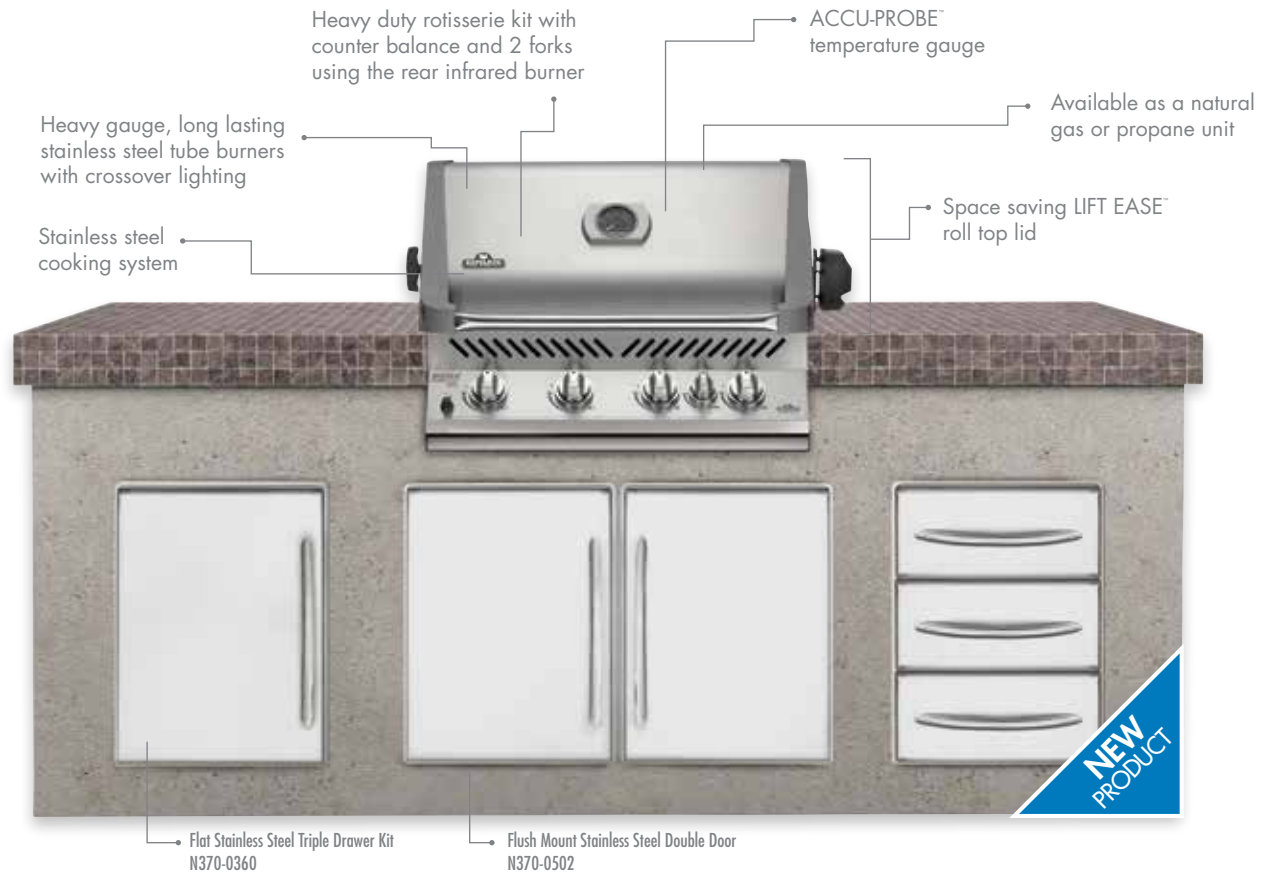

**NEW PRODUCT**

Serves: 

Prep Time: 20 minutes

Grilling Time: 20 to 30 minutes

- Using the Napoleon® Marinade Injector, inject the centre of each chop with one-quarter cup of the Buffalo injector sauce. Rub the chops with Cajun Creole spice, massaging seasoning into the meat. Cover and refrigerate until needed.
- In a small bowl, whisk together remaining Buffalo injector sauce and thick Balkan-style honey until combined and smooth. Set aside.
- Preheat grill to medium-high heat.
- Lightly brush corn, red onion, red pepper, and jalapeño pepper with olive oil, and season to taste with Cajun Creole spice. Place vegetables onto grill and cook until lightly charred and tender, about 4 to 5 minutes. Remove vegetables from grill and allow to cool. Remove kernels from corn, and finely dice onion, red pepper and jalapeño pepper. Place into a medium-sized bowl with one-quarter cup olive oil, lime juice and chopped cilantro. Mix well and season with salt and coarsely ground black pepper to taste. Cover and refrigerate until needed.
- Place seasoned chops onto grill and sear for 2 to 3 minutes on each side. Reduce heat to medium-low and close the lid. Slow roast for an additional 10 to 12 minutes, turning and basting occasionally with the Buffalo and honey mixture, until chops are just cooked through and juices run clear. Give chops a final baste and remove from grill.
- Serve immediately, topped with fire roasted corn salsa and extra basting sauce on the side.

Doors and drawers are optional. Island not included.



Porcelainized Cast Iron WAVE® Reversible Channel Cooking Grids



Dual-Level, Stainless Steel Sear Plates



JETFIRE® Ignition



Rear Infrared Rotisserie Burner



 Proudly Made in Canada

### DUAL-LEVEL STAINLESS STEEL SEAR PLATES

Dual-Level, individual stainless steel sear plates allow consistent, even heat and continuous grease run off. (Standard on BIPRO825RBI, BIPRO665RBI, BIPRO500RB & BIP500RB)



# MIRAGE™ SERIES

## BIM730RBI-1, BIM605RBI-1 WITH REAR INFRARED BURNER AND INFRARED SIZZLE ZONE™ BOTTOM BURNER



Doors and drawers are optional. Island not included.



JETFIRE™ Ignition



i-GLOW™ Backlit Control Knobs



Ceramic Infrared Rear Burner

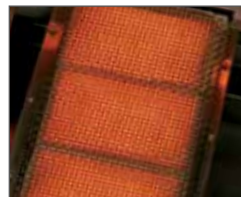

Infrared SIZZLE ZONE™ Bottom Burner



### ACCU-PROBE™ TEMPERATURE GAUGE

Safely and instantly read the internal temperature of your grill with the lid closed. This thermometer has a wide temperature measurement range from 0° to 370°C (0° to 700°F) and includes the ideal smoking and searing range.

BIM730RBI-1  
Up to 95,500 BTU's  
Up to 6 burners  
Cooking Area: up to 1025 in<sup>2</sup> (6530 cm<sup>2</sup>)  
Cart Models Available

BIM605RBI-1  
Up to 79,500 BTU's  
5 burners  
Cooking Area: 850 in<sup>2</sup> (5440 cm<sup>2</sup>)  
Cart Models Available

## CEDAR PLANKED BRIE CHEESE WITH FRESH BERRIES

<b>Napoleon® Cedar Plank</b> soaked in water for one hour minimum	1		1
<b>Brie Cheese</b>	2 x 4½ oz		125 g
<b>Strawberries</b> trimmed and sliced into quarters	1 cup		250 mL
<b>Fresh Berries</b> blueberries, raspberries, or blackberries	1 cup		250 mL
<b>Raspberry Jam</b>	½ cup		125 mL
<b>Sauvignon Blanc</b>	¼ cup		60 mL
<b>Black Pepper</b> coarsely ground	to taste		





# MIRAGE™ SERIES

## CLASSIC BIM485-2 WITH 3 BURNERS

Up to 48,000 BTU's  
3 burners  
Cooking Area: up to 675 in<sup>2</sup> (4350 cm<sup>2</sup>)  
Cart Models Available

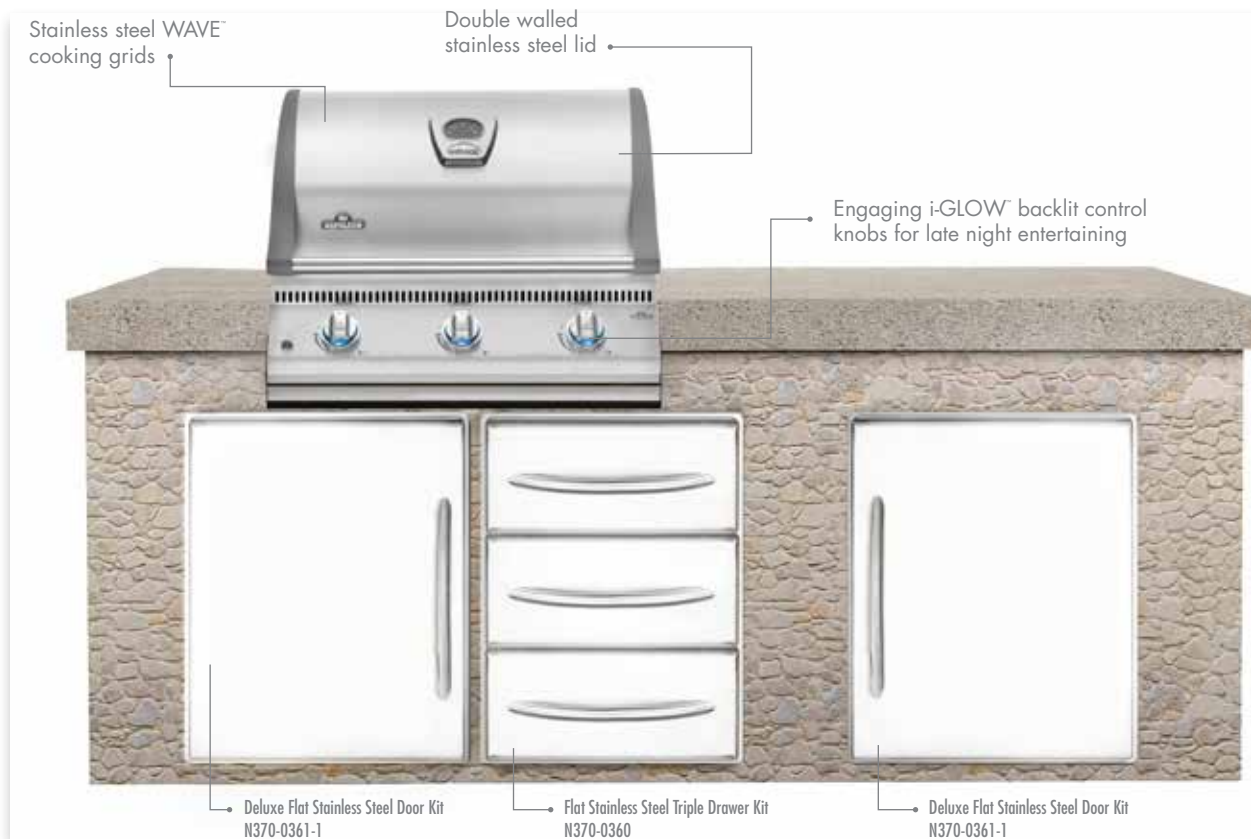

Doors and drawers are optional. Island not included.



JETFIRE™ Ignition



i-GLOW™ Backlit Control Knobs



Stainless Steel WAVE™ Cooking Grids



ACCU-PROBE™ Temperature Gauge



Serves:

Prep Time: 1 hour

Grilling Time: 10 to 12 minutes

1. Soak your cedar plank for a minimum of 1 hour in cold water.
2. Place the Brie wheels spaced evenly on the presoaked plank. Place all berries into a mixing bowl, pour in white wine and jam and toss gently to combine. Season with coarsely ground black pepper to taste.
3. Preheat grill to medium heat.
4. Spoon the berry mixture evenly over the top of the two wheels of cheese.
5. Place the plank onto the preheated grill and close the lid. Plank bake Brie for 10 to 12 minutes, or until sides are bulging and golden brown.

Remove plank from grill and serve with slices of fresh baguette or crackers and plenty of napkins.

### CERAMIC REAR INFRARED ROTISSERIE BURNER

Ceramic rear rotisserie burner heat waves seal and lock in the juices quickly for superior tenderness. Restaurant style results and perfect self-basting roasts every time. (Heavy duty rotisserie kit with counter balance, stainless steel rotisserie bracket and forks available for most models).



# OASIS™ MODULAR ISLANDS

## ENDLESS CONFIGURATION POSSIBILITIES

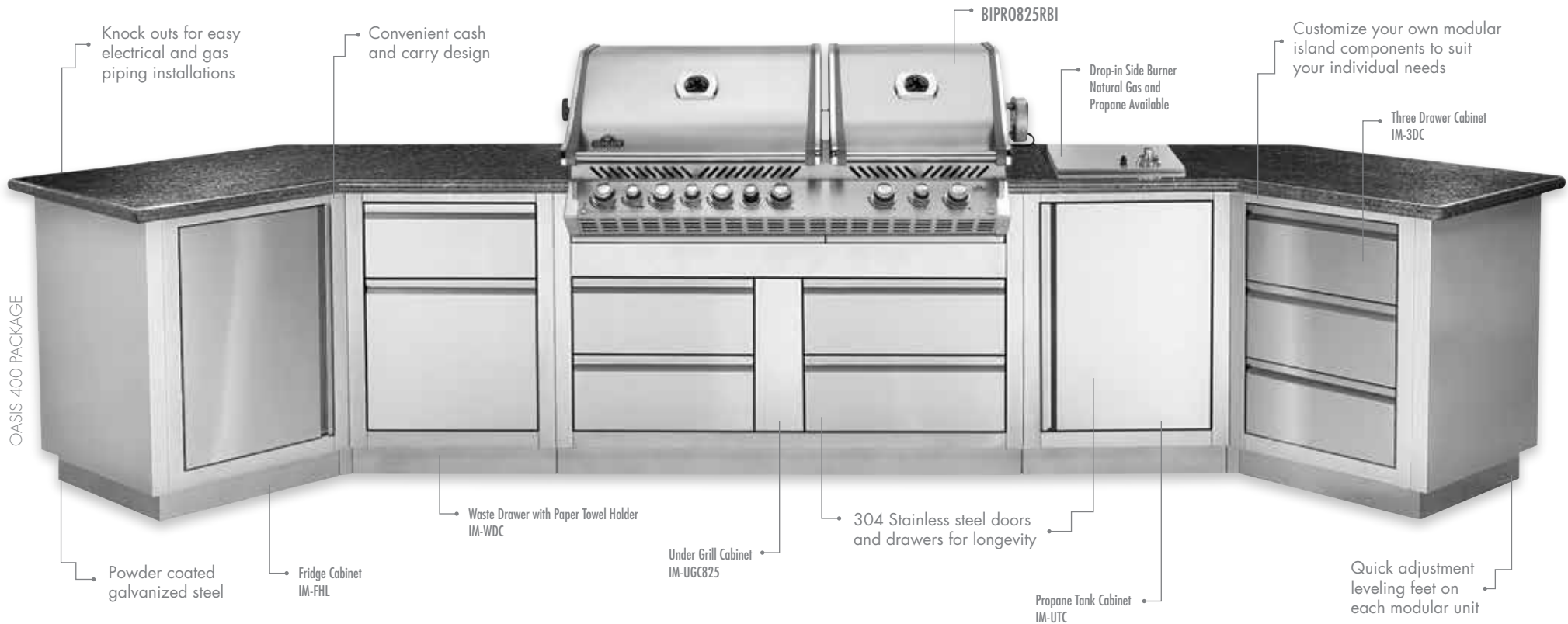

### LATE NIGHT ENTERTAINING

Being the biggest fans of BBQ, Napoleon® feels you should always be able to enjoy your favorite grilled meal and we have developed technology that makes every meal better and more easily prepared. You can entertain into the late hours with features such as interior lights and i-GLOW™ and NIGHT LIGHT™ control knobs that illuminate for easy grilling and food preparation. Wishing you many unforgettable meals – grilled to perfection.

The Napoleon® Oasis™ Modular Island series has been developed with versatility in mind.

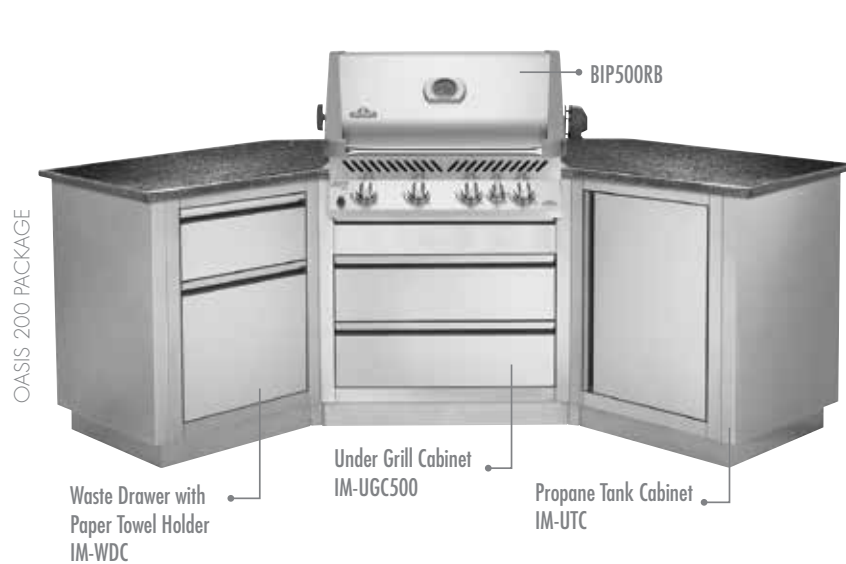

### PERSONALIZE YOUR OUTDOOR LIVING SPACE WITH THE LUXURIOUS OASIS™ MODULAR ISLANDS

Choose the modules that fit your lifestyle and your budget. The cabinets can be assembled in virtually any combination to suit your individual needs. All cabinets are 35 ½" tall and 24" deep with 4 leveling feet for easy adjustment on any surface. The Oasis™ Outdoor Modular island series can be assembled against any non-combustible wall of your home or as a standalone island.

# OASIS™ MODULAR ISLAND COMPONENTS



**Under Grill Cabinets**

IM-UGC485, IM-UGC500, IM-UGC605  
IM-UGC665, IM-UGC730



**Under Grill Cabinet**

IM-UGC300  
Fits side burners BISZ300, BISZ300FT, BISB245



**Under Grill Cabinet**

IM-UGC825



**Three Drawer Cabinet**

IM-3DC



**Two Drawer Cabinet**

IM-2DC



**Waste Drawer with  
Paper Towel Holder**

IM-WDC



**Propane Tank or Universal Cabinets**

IM-UTC (Shown), IM-UDC  
Left or right opening



**Fridge Cabinet**

IM-FHR, IM-FHL  
Includes Danby 2.5 cu.ft general purpose fridge

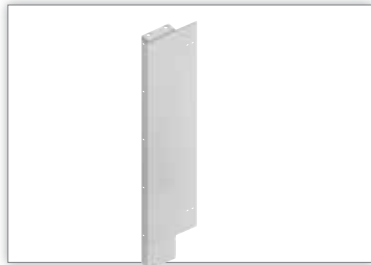

**Wall Spacer**

IM-WSF



**Cabinet Transitions**

IM-45T = 45°



**Cabinet End Panel**

IM-CEP

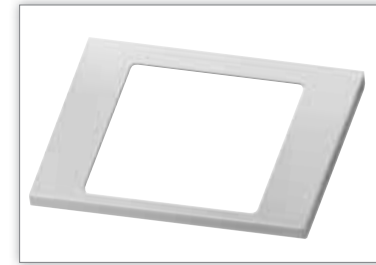

**Ice Bucket Holder**

IM-IBA

## FINDING THE PERFECT STEAK

When buying a large steak, choose one that has a uniform thickness of about 1 1/2". Buy a top quality cut that is well marbled to ensure tenderness. The better the quality of beef, the tastier your steak will be. For a quick sauce, jazz up store-bought BBQ sauce by adding chopped chilies, a little Worcestershire sauce, a splash of vinegar, some chopped fresh onions or garlic, or get creative.



## BUILT-IN ISLAND DOORS, DRAWERS & BURNERS



Deluxe Flat Stainless Steel Door Kit  
with Curved Stainless Steel Handle  
N370-0361-1



Flush Mount Stainless  
Steel Double Doors  
N370-0502, N370-0503



Drop-in Side Burner  
N370-0504 (LP), N370-0505 (NG)



Deluxe Stainless Steel Triple Drawers  
with Curved Stainless Steel Handles  
N370-0360



Deluxe Stainless Steel Single Drawer  
with Curved Stainless Steel Handle  
N370-0359



Double Side Burner  
BISB245FT



Infrared SIZZLE ZONE™ Side Burner  
BISZ300 with LIFT EASE™ Roll Top Lid



Infrared SIZZLE ZONE™ Side Burner  
BISZ300FT with Stainless Steel Flat Cover

### INSTANT JETFIRE™ IGNITION

Napoleon's JETFIRE™ ignition starts each burner individually for reliable start ups - EVERY time.



# EVERYDAY GRILLING ACCESSORIES

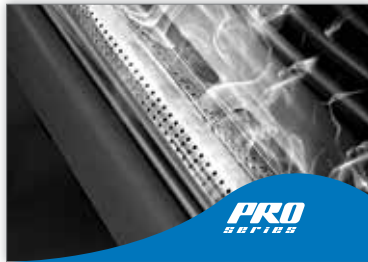

Smoker Pipe  
67011



Professional Spatula  
70010



Stainless Steel Griddles



Stainless Steel Grill Brush  
62035



Professional Five Piece Toolset  
70011



6 Stainless Steel Skewers - 14"  
70016



Salt and Pepper Grinders  
70004/70005



Tomato and Pepper Roasting Racks  
56028/56029



Dual Universal Handle Lights  
70021

Visit [napoleongrills.com](http://napoleongrills.com) to see Napoleon's complete line of grilling accessories.

## HERBS & SPICES

Dried herbs and spices make wonderful aromatics for grilling. Soak them for about 5 minutes, squeeze out the moisture, and sprinkle them either directly on the coals, or even in the water pan if you're cooking over indirect heat. Watch out for seeds, such as mustard and coriander. Heat makes them pop.

THE MOST  
VERSATILE COOKING  
STYLES AVAILABLE

—NAPOLEON—  
EXPERTS IN  
GAS & INFRARED  
GRILLING

## Direct Cooking

This method of cooking utilizes all burners, cooking the food directly above the flame "GRILLING" style, for searing steaks, other meats or vegetables. Keeping the lid down reduces the cooking time and cooks through to the center faster than with the lid up. Anything that is less than two inches in thickness should be cooked by direct grilling. These are things that generally cook quickly and benefit from the fast cooking of a hot grill. Front to back burners were designed for precise heat control, allowing for independent use of each cooking zone.

## Indirect Cooking

Indirect grilling is similar to baking. The food is placed above the unlit burner instead of directly over the flame. This can be achieved by only igniting some of the burners – light one side on high and cook the food on the other. The food will cook more evenly as it is not exposed to direct heat from the burners. This is an excellent way to cook tough cuts of meat, like brisket and ribs, that require long, slow cooking at a low or moderate heat. Indirect grilling allows you to work over a more moderate temperature (275° to 350°) and makes it easy to introduce a smoker pipe for extra flavor. For chicken, game, turkey, roasts, ham, vegetables, bread or combinations, the indirect cooking method gives great results every time. There is little need to turn the food. You can place the food directly on the grids or in a cooking pan.

## Charcoal Cooking

Unique to Napoleon! Optional charcoal trays give you the freedom to switch from gas to charcoal with relative ease. With charcoal you can utilize indirect cooking as well as direct cooking.

## Rotisserie Cooking

Rotisserie cooking allows the food to self-baste, sealing in the juices while browning the outside surface. Use the rotisserie method of cooking for large cuts of meat like roasts, poultry or legs of lamb. There are so many advantages to rotisserie cooking. Meats are generally juicier, self-basted and slow roasted. You can use the rotisserie method if your grill comes with a rear rotisserie burner, which requires much less attention than any other cooking method. The rotisserie burner is a nice feature because it automatically sets you up for direct, even heating.

## Infrared Bottom Burner Cooking

Do you want to make the perfect steak? The intense 1800° heat instantly sears the meat, locking in the juices. Larger cuts of meat may be moved to the side of the grill to continue cooking.

## Smoking

Place wet wood chips into the smoker tube and place over the left burner, then turn the burner on. Place your meat over the right burner, but do not turn on that burner. You are using the indirect cooking method. Smoke the meat for several hours under a closed lid. To achieve maximum flavor, fresh wood chips may be added several times during the cooking process.

# FOR EVERY DELICIOUS OCCASION



Wok & Beer Can Chicken Roaster  
56020



Drip Trays  
62008



Professional Cast Iron Skillet  
56003



Rotisserie Kits



Rotisserie Shish Kebab Wheel  
64007



Rotisserie Motors with Light



Cast Iron Charcoal/Smoker Tray  
67731



Stainless Steel Rotating  
Skewer Rack  
70014



Charcoal Baskets  
67400

Visit [napoleongrills.com](http://napoleongrills.com) to see Napoleon's complete line of grilling accessories.

—NAPOLEON—  
**EXPERTS IN  
GAS & INFRARED  
GRILLING**

## TROUBLE-FREE GRILLING

If you take the time to give your grill a thorough check-up in the spring and once more in the fall, you will enjoy years of trouble-free grilling. If you can't fit both check-ups in, choose the springtime, just before the busy summer grilling season starts, to get at least one good check-up.

# COOKING WITH CHARCOAL ON YOUR GAS GRILL

A Napoleon Exclusive! The optional charcoal tray gives you the freedom to switch from gas to charcoal with relative ease. Simply replace your sear plates with the charcoal tray, fill with charcoal and light using your gas burners. Replace your cooking grids and now you're charcoal grilling!

Before you begin to use your charcoal tray, you will need to determine how much charcoal you are going to need. Approximately one layer for burgers or steaks and two layers for roasts or chicken. Pour enough charcoal into the tray to make the layers needed. Light the gas burner(s) directly under the charcoal tray and burn on high until the charcoal is glowing red and then turn off the gas burner(s). Let coals burn until all coals are white on the surface. With a long handle instrument, spread the coals evenly across the tray.

**Still want the convenience of gas, but long for that charcoal flavor?**

No problem! Napoleon's charcoal tray lights easily with your gas burner.

**Tip:** Never add lighter fluid to burning coals. Even if there is no flame, the heat will vaporize the lighter fluid and can cause a serious flare-up the second the vapor encounters a flame.



## Want That Smoky Goodness?

Enjoy that delicious smoked meat flavor at home with your own grill and a few pointers from Napoleon®. When using gas grills, it's best to put presoaked wood chips in our smoker tube, available at Napoleon® grill retailers. This keeps your grill from filling up with ashes and clogging the jets. If you are using a charcoal tray, then you can either put the wood directly on the preheated coals or place them in the wood chip chamber in the tray.

Fill the stainless steel smoker tube with wood chips. Submerge in water for at least half an hour. Place the smoker tube over the left burner and turn it on. Place your meat over the right burner, but do not turn on the burner. You are using the indirect smoking cooking method.

Smoke the meat for several hours under a closed lid. To achieve maximum flavor, add fresh, pre-soaked wood chips several times during the cooking process or use two tubes.

## OVEN-LIKE PERFORMANCE

Your gas grill can also be used as a conventional or convection oven. Bread, buns, cakes and pizzas can be cooked to perfection under the grill lid. For convection cooking, follow the same instructions as for the indirect cooking method. Your grill comes with a tightly sealed lid for heat retention, giving oven-like performance.



# HOW DOES INFRARED COOKING WORK?

Since the discovery of fire, man-kind has been striving to improve taste and perfect the grilling experience. Infrared grilling is simply the relationship between the type of food, heat, and time. Infrared cooking uses high-efficiency radiant energy, much like the sun. High-frequency electromagnetic waves from the invisible end of the light spectrum travel from the infrared source to the food.

Napoleon® infrared grills use ceramic burners with thousands of evenly spaced flame ports to generate infrared radiant energy. The flame energy is absorbed by the ceramic, which then glows and heats up to an incredible 1800°F. This remarkable SIZZLE ZONE™ heat intensity quickly sears your food to lock in moisture and flavor. The results are unmistakable - succulent, flavorful food in a much-reduced grilling time! Napoleon's infrared grilling technology makes serving the perfect meal quick and easy each and every time.

## Versatile

Grill anything like a professional, from steaks to seafood, fish to vegetables.

## Great Retention of Flavor and Moisture

Infrared provides the heat necessary to lock in the juices with little or no preheating time. Radiant energy is delivered more directly to the food, and warms less air. Therefore, the food cooks very quickly, resulting in a greater retention of food weight. Food cooked in it's own juices is more succulent, tender and tasty.

## More Efficient

Infrared heats the object not the air so it cooks twice as fast as traditional burners while using less fuel. Because infrared heats food directly, not the air around it, grilling year round is much easier.

## The Environmental Choice!

Because the infrared burners are ready to grill in under a minute and grilling time is drastically decreased, cooking your food with Napoleon's advanced infrared technology can reduce your gas consumption by up to 50%.

## BTU CONSUMPTION

TRADITIONAL  
GRILLING

NAPOLEON®  
INFRARED GRILLING

## How To Cook The Perfect Infrared Steak

Pick a steak that is well marbled, the more marble there is inside, the more flavorful and tender your steak will be. A perfect steak size is about 1 ½ to 2 inches thick and about 12 to 16 ounces each, depending on the cut.

1. Lift lid of grill or side burner.
2. Ignite infrared burner.
3. Warm up for one minute.
5. Place thick, juicy steak on grids.
6. Wait two - three minutes, flip steak with tongs. (You do not want to use a fork and pierce the steak as this will let out the juices the infrared has locked in).
7. Wait another two – three minutes, turn off the red knob.
8. You now have a medium rare steak.  
Bon Appetite.

Note: Never cut a steak to see if it is done – use a meat thermometer. Cutting allows all the natural juices to escape.

## “DONENESS” TEST

Take your left forefinger and touch it to the tip of your left thumb. Don't apply pressure, just use the lightest touch with your finger, touching the base of the meaty part of your thumb. This feeling is similar to the consistency of rare steak. Now compare it by touching the steak. For medium done, use the second finger of your left hand to touch the tip of your left thumb. Well done, use the third finger of the left hand.

# INSTALLATION SPECIFICATIONS

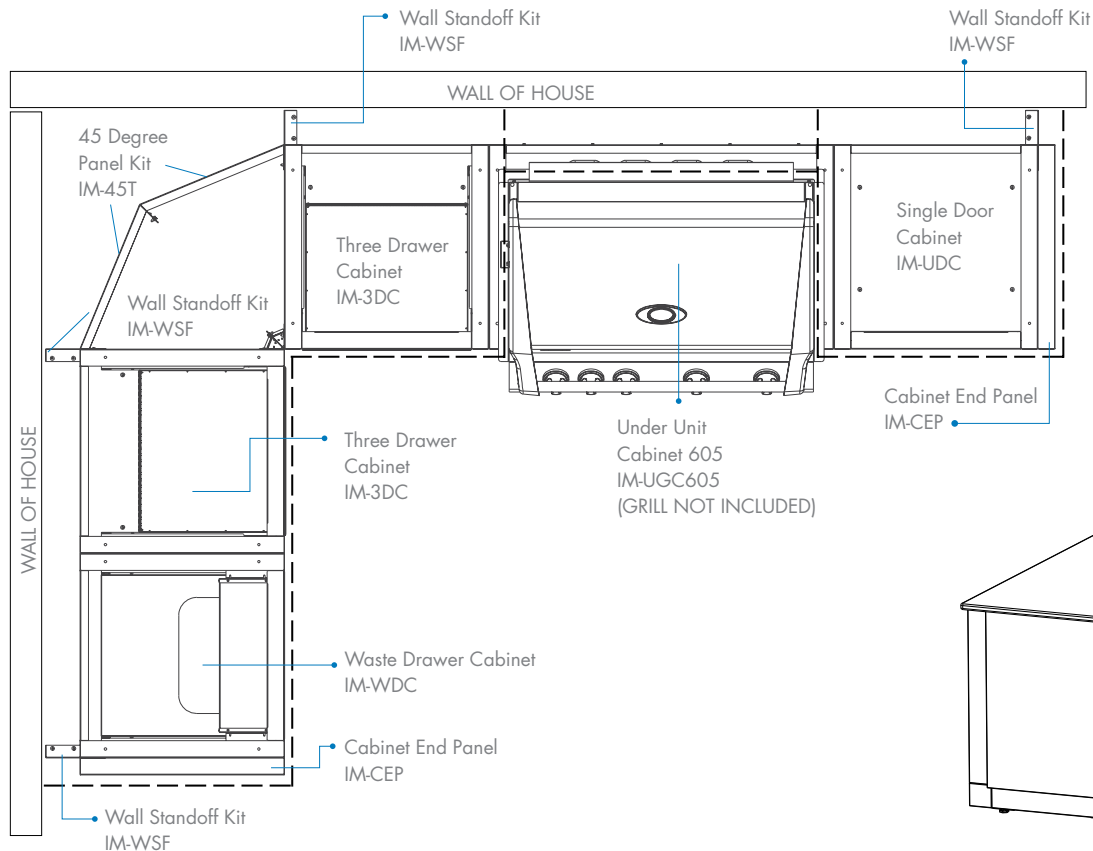

## Oasis™ Modular Island Sample

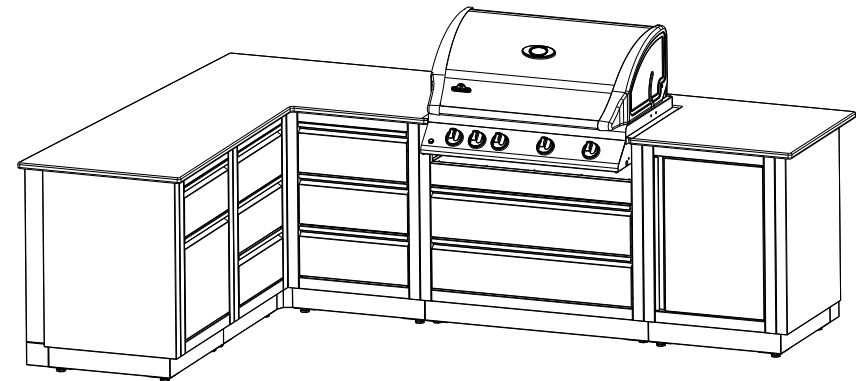

The countertop material must be non-combustible if a grill is to be installed into it. They can be ordered in advance by drawing out the floor plan of how the cabinets will be situated and adding up the width measurements, allowing 1-2" of countertop overhang. Most countertop manufacturers are willing to come and take measurements after assembly of the cabinets is complete to ensure a perfect fit. For best results the countertop thickness should be between ¾" to 1 ½" thick. The built-in grill head comes with stainless steel brackets and hardware that allow the unit to rest on the countertop above the corresponding island cabinet for that unit. Granite is an excellent choice of countertop materials. Decorative countertops made of ceramic tile set on top of cement tiling board can be selected to match your surrounding backyard furniture color.

\* Countertops must be ordered and supplied locally by the homeowner.

### BUILT-IN NATURAL GAS HOOK-UP

The piping up to the gas grill is the responsibility of the installer and piping should be located as shown in the built-in instructions. Do not use hose to connect the unit. It must be connected with rigid pipe, copper tube or an approved flexible metal connector which complies with Z21.4 /CSA 6.10. The installation must comply with CAN B149.1 Natural Gas and Propane Installation Code in Canada, or to the National Fuel Gas Code, ANSI Z223.1 in the United States. The gas supply pipe must be sufficiently sized to supply the BTU/h specified on the rating plate, based on the length of the piping run. If installing a side burner, a separate line must be branched off to the side burner unit and enter the side burner opening at the specified location.

# INSTALLATION SPECIFICATIONS

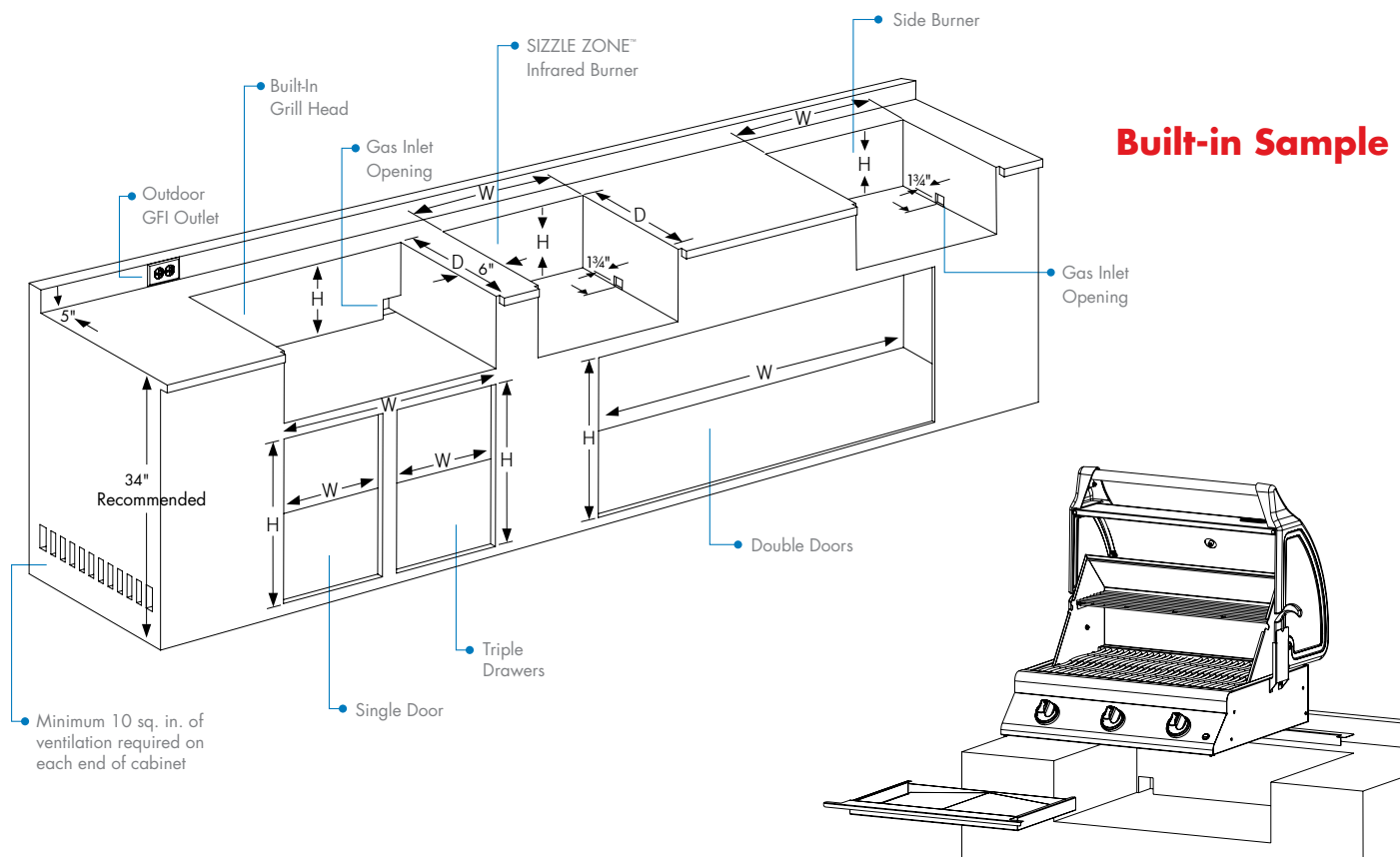

Please use manual to properly assemble your built-in grill. Refer to the main manual for operating, cleaning, and maintenance instructions. This grill is designed for non-combustible enclosures only (unless the Napoleon® zero clearance kit is utilized), and must be installed and serviced by a qualified installer to local codes.

Drawings for reference only. Minimum 6" clearance required between grill and other appliance. Specifications subject to change without notice.

\* Additional clearance may be required for openings. See owners manual

## BUILT-IN PROPANE GAS HOOK-UP

The piping up to the gas grill is the responsibility of the installer and piping should be located as shown in the built-in instructions. The installation must comply with CAN B149.1 Natural Gas and Propane installation code in Canada, or to the National Fuel Gas code, ANSI Z223.1 in the United States. The tank can not be stored below the gas grill. Built-in units are supplied with a drip pan which holds only a minimal amount of grease. To prevent grease fires, the pan must be cleaned after each use.

# BUILT-IN GRILL HEADS AVAILABLE FOR YOUR CUSTOM OASIS™ ISLAND



## **BIPRO500RB**

Opening dimensions:  
30 3/4" w x 20 5/8" d x 8 7/8" h  
(78 cm w x 52 cm d x 23 cm h)



## **BIPRO665RB**

Opening dimensions:  
38" w x 20 5/8" d x 8 7/8" h  
(97 cm w x 52 cm d x 23 cm h)



## **BIPRO825RBI**

Opening dimensions:  
52 3/8" w x 20 5/8" d x 8 7/8" h  
(133 cm w x 52 cm d x 23 cm h)



## **BIP500RB**

Opening dimensions:  
30 3/4" w x 20 5/8" d x 8 7/8" h  
(78 cm w x 52 cm d x 23 cm h)



## **BIM485-2**

Opening dimensions:  
29 3/4" w x 21 3/8" d x 7 1/2" h  
(76 cm w x 54 cm d x 19 cm h)



## **BIM605RBI-1**

Opening dimensions:  
36 1/2" w x 21 3/8" d x 7 1/2" h  
(93 cm w x 54 cm d x 19 cm h)



## **BIM730RBI-1**

Opening dimensions:  
43 1/4" w x 21 3/8" d x 7 1/2" h  
(110 cm w x 54 cm d x 19 cm h)

### **ALL SEASON GRILLING**

The secret to grilling success in any season, is preparation. Always locate your grill away from the wind in a well-ventilated location to ensure consistent heat. Don't let the heat escape by constantly lifting the lid to check; instead use your thermometer. And, don't be afraid to use the warming rack to keep food warm or to finish cooking, if the rest of your food continues to cook on the main burners.



GRILL SPECIFICATIONS	BIPRO825RBI	BIPRO665RB	BIPRO500RB	BIP500RB	BIM730RBI-1	BIM605RBI-1	BIM485-2
LIFT EASE™ roll top stainless steel lid	S	S	S	S	-	-	-
Double walled stainless steel lid	-	-	-	-	S	S	S
ACCU-PROBE™ temperature gauge	S	S	S	S	S	S	S
Total cooking surface (sq. in.)*	1245	1000	760	760	1025	850	675
Electronic ignition	S°	S°	S°	S°	-	-	-
JETFIRE™ ignition	-	S	-	S	S	S	S
Infrared ceramic bottom burners	2	-	-	-	1	1	-
Stainless steel bottom burners	4	5	4	4	4	3	3
Infrared rear rotisserie burner	S	S	S	S	S	S	-
Integrated wood chip smoker tray	S	S	-	-	-	-	-
Stainless steel WAVE™ cooking grids	-	-	-	-	S	S	S
Stainless steel 9.5 mm WAVE™ cooking grids	S	S	S	-	-	-	-
Porcelain cast iron WAVE™ reversible channel cooking grids	-	-	-	S	-	-	-
i-GLOW™ / NIGHT LIGHT™ control knobs	S	S	S	-	S	S	S
Interior lights	S	S	-	-	-	-	-
EASY SET™ control knobs	S	S	S	S	S	S	S
Removable drip pan	S	S	S	S	S	S	S
Warming rack	S	S	S	S	S	S	S
President's Limited Lifetime Warranty	S	S	S	S	S	S	S

DIMENSIONS (opening size for installation)	BIPRO825RBI	BIPRO665RB	BIPRO500RB	BIP500RB	BIM730RBI-1	BIM605RBI-1	BIM485-2
Total width in inches (cm)	52 3/8 (133)	38 (97)	30 3/4 (78)	30 3/4 (78)	43 1/4 (110)	36 1/2 (93)	29 3/4 (76)
Total depth in inches (cm)	20 5/8 (52)	20 5/8 (52)	20 5/8 (52)	20 5/8 (52)	21 3/8 (54)	21 3/8 (54)	21 3/8 (54)
Total height in inches (cm)	8 7/8 (23)	8 7/8 (23)	8 7/8 (23)	8 7/8 (23)	7 1/2 (19)	7 1/2 (19)	7 1/2 (19)

DOORS & ACCESSORIES (opening size for installation)	Part Number	Width in. (cm)	Depth in. (cm)	Height in. (cm)	OASIS™ MODULAR COMPONENTS	Part Number	Width in. (cm)	Depth in. (cm)	Height in. (cm)
Flat Stainless Steel Door	N370-0361-1	17 (43)	-	23 1/4 (59)	Under Grill Cabinet - 825 series	IM-UGC825	55 (139)	24 (61)	35 1/2 (90)
Flushed Mount Stainless Steel Double Door	N370-0502	28 3/4 (72)	-	20 1/4 (51)	Under Grill Cabinet - 665 series	IM-UGC665	40 1/2 (103)	24 (61)	35 1/2 (90)
Flushed Mount Stainless Steel Double Door	N370-0503	37 3/4 (96)	-	20 1/4 (51)	Under Grill Cabinet - 500 series	IM-UGC500	34 3/4 (88)	24 (61)	35 1/2 (90)
Stainless Steel Single Drawer	N370-0359	17 1/4 (44)	23 (58)	6 3/4 (17)	Under Grill Cabinet - 730 series	IM-UGC730	47 1/4 (120)	24 (61)	35 1/2 (90)
Stainless Steel Triple Drawer	N370-0360	17 1/4 (44)	23 (58)	22 3/4 (58)	Under Grill Cabinet - 605 series	IM-UGC605	40 1/2 (103)	24 (61)	35 1/2 (90)
Infrared SIZZLE ZONE™ Burner with Roll Top	BISZ300	20 1/8 (51)	23 3/4 (52)	8 7/8 (23)	Under Grill Cabinet - 485 series	IM-UGC485	34 3/4 (88)	24 (61)	35 1/2 (90)
Infrared SIZZLE ZONE™ with Flat Top	BISZ300FT	20 1/8 (51)	23 3/4 (52)	8 7/8 (23)	Propane Tank Cabinet - universal door	IM-UTC	24 (61)	24 (61)	35 (140)
Double Side Burner	BISB245	20 5/8 (52)	20 5/8 (52)	8 7/8 (23)	Universal Door Cabinet	IM-UDC	24 (61)	24 (61)	35 (140)
Side Burner	N370-0504/05	12 3/4 (32)	16 1/2 (42)	4 1/2 (11)	Fridge Cabinet	IM-FDC	24 (61)	24 (61)	35 (140)
Zero Clearance (2) 37"	BIZC600	44 1/8 (112)	11 1/8 (28)	22 15/16 (58)	Three Drawer Cabinet	IM-3DC	24 (61)	24 (61)	35 (140)
					Two Drawer Cabinet	IM-2DC	24 (61)	24 (61)	35 (140)
					Waste Drawer with Paper Towel Holder	IM-WDC	24 (61)	24 (61)	35 (140)
					Cabinet End Panel	IM-CEP	2 (61)	24 (61)	31 (78 3/4)
					Cabinet Transitions - 45 degrees	IM-45T	18 3/8 (47)	-	35 (140)
					Wall Spacer	IM-WSF	1 1/2 (4)	4 (10)	35 (140)
					Ice Bucket Holder	IM-IBA	19 1/8 (48 1/2)	16 (41)	1 3/8 (3)

S = Standard O = Optional ° Rear burner \* All lid openings require a minimum of 5" clearance behind the unit. Refer to owners manual for individual models. - Dimensions subject to change. Refer to manual for accurate dimensions.

Other Napoleon Products



Fireplace Inserts • Charcoal Grills • Hybrid Furnaces • Outdoor Fireplaces  
Gas Furnaces • Gas Fireplaces • Electric Fireplaces • Accessories • Wood Stoves



214 Bayview Drive, Barrie, Ontario, Canada L4N 4Y8  
103 Miller Drive, Crittenden, Kentucky, USA 41030  
7200 Trans Canada Highway, Montreal, Quebec H4T 1A3

PHONE: 705-726-4278 FAX: 705-725-2564  
napoleongrills.com  
info@napoleonproducts.com

Approved by Intertek Testing Services to standards in the USA and Canada: ANSI Z21.58 / CSA 1.6 - Outdoor Cooking Gas Appliances. All specifications and designs are subject to change without prior notice due to ongoing product improvements. Consult your owner's manual for complete installation and operating instructions and check all local and national Building Codes and Regulations. Not all features available on all models. Napoleon is a registered trademark of Wolf Steel Ltd. Images and colors may not be exactly as shown.

Authorized Dealer



Printed in Canada  
ADBRI 05/2014