

NAPOLEON®

WOOD BURNING

WOOD BURNING FIREPLACES



napoleonfireplaces.com



Add an element of “home” to your house with a Napoleon® wood burning fireplace.

NZ6000 High Country™	4 - 5
NZ3000 High Country™	6 - 7
NZ-26 Prestige®	8 - 9
Anatomy of the Perfect Fireplace	10 - 13
Options, Features & Accessories	14
Detailed Specifications.....	15



NZ3000 shown with painted black faceplate, Heritage insets and black cast iron doors with brushed copper plated inlay



Why a Napoleon® Wood Burning Fireplace?

The answer is quite simple. No other hearth manufacturer in North America has perfected wood burning technology to the level that Napoleon® has... perfecting true craftsmanship to last a lifetime. Years of research, strict quality testing and advanced wood burning technology have surpassed critical standards, providing you with the cleanest, most efficient wood burning products. Napoleon® products are backed by the President's Limited Lifetime Warranty, guaranteed to give you the solid performance you deserve.

Best Burn Times In The Industry... Napoleon® wood burning products offer state-of-the-art technology, unlike any others, completely utilizing the firebox chamber with a fully lined refractory system. The kiln-like atmosphere allows for an amazing long day or overnight burn. The single lever combustion control allows for simple regulation of the burn rate.

No Power? No Problem!... We all feel vulnerable when there is a power outage, but with a Napoleon® wood burning fireplace you can rely on comfort and heat when you need it most. Rest assured, you can enjoy a cozy, warm atmosphere when the power is out!

Warming Homes, Not The Environment... Napoleon® products are designed not only for outstanding heating efficiencies but Napoleon® also takes great pride in their commitment to provide environmentally friendly wood burning products. Napoleon's wood burning technology exceeds EPA (Environmental Protection Agency) standards burning very clean with low emissions, helping to make a difference in keeping our environment safe.



NZ6000 - High Country™

A Showcase For Your Home



Napoleon's dedicated team of designers and engineers have taken wood burning to a higher level and created a distinctive fireplace experience never seen before in the industry! The perfect blend of elegant, rustic styling and state-of-the-art wood burning technology makes this luxurious fireplace an ideal choice to add class and artistry to your home. With an impressive 792 sq. in. viewing area the NZ6000 High Country™ stands out in the crowd and is well deserving of the Napoleon® insignia. Treasured for its quality and performance, every Napoleon® fireplace is hand crafted to last for generations.

NZ6000

Up to 100,000 BTU's

41" w x 36 1/2" h as shown

EPA Certified – Exempt



NZ6000 shown with painted black double doors, faceplate and keystone

For more detailed specifications on this unit, see pages 10 & 11

Options & Accessories



Complete Arched Wrought Iron Double Doors, Faceplate, Grill & Keystone



Andirons Painted Black Finish (standard)



Arched Screen Kit



Country Crane & Hearth Pot



Powerful "Whisper Quiet" Blower System with Washable Filter



Arched Faceplate Three Colour Options*

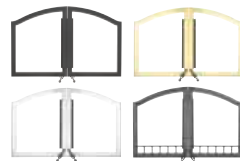

Arched Double Doors Four Colour Options*

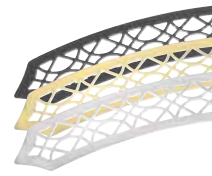

Arched Upper Grills Three Colour Options*



Keystones Three Colour Options*





NZ6000 shown with wrought iron double doors, faceplate, upper grill and keystone

 HIGH
COUNTRY

 **NAPOLEON**
QUALITY FIREPLACES

NZ3000 - High Country™

Wood Burning Elegance



Napoleon's EPA certified NZ3000 wood burning fireplace is the smaller version in the powerful High Country™ Series. The NZ3000 offers superior heavy duty boiler plate steel, full refractory lined firebox with advanced EPA technology and ultra high efficiencies which allow for easily sustained overnight burns. Five stainless steel secondary air tubes supercharge the fuel burning process and generates a fascinating display of YELLOW DANCING FLAMES®. Only Napoleon® provides wood burning fireplaces that have an elegant, rustic style and are built to these high quality standards.

NZ3000

Up to 60,000 BTU's

40" w x 30 1/4" h as shown

EPA Certified

For more detailed specifications on this unit, see pages 10 & 12

Options & Accessories



Complete Arched Wrought Iron Double Doors, Faceplate, Grill & Keystone



Andirons Painted Black Finish (standard)



Powerful "Whisper Quiet" Blower System with Washable Filter



Arched Faceplate & Modern Inset Painted Black Finish



Arched Faceplate & Heritage Inset Painted Black Finish



Door Inlays Two Colour Options*



Arched Screen Kit



NZ3000 shown with cast iron double doors with stainless steel inlays and modern insets





NZ3000 shown with wrought iron double doors, faceplate, upper grill and keystone

HIGH
COUNTRY

NAPOLEON®
QUALITY FIREPLACES

NZ-26 - Prestige®

Exceptional Heat Performance

The NZ-26 features Napoleon's exclusive PHAZER® light weight ceramic baffle which heats up quickly to help increase efficiencies and comes complete with an ash pan and lid for easy cleaning. A full brick patterned refractory liner retains heat and supports overnight burn. The airwash system ensures an extremely clean viewing area. The Prestige® NZ-26 zero clearance masonry fireplace outperforms your expectations by providing optimum heating efficiency, durability, environment friendly wood burning technology and exceptional heat performance that will last a lifetime!

NZ-26

Up to 70,000 BTU's

38 ¼" w x 39 ½" h as shown

EPA Certified

For more detailed specifications on this unit, see pages 10 & 13



NZ-26 shown with satin chrome plated webbed arched door and louvers



Options & Accessories



Webbed Arched Door
Three Colour Options*



Arched Door
Three Colour Options*



Upper & Lower Louvres
Four Colour Options*



Spring Door Handles
Three Colour Options*



Cast Iron Surround
Painted Black Finish



NZ-26 shown with painted black arched door, spring door handle and louvres

Outstanding Features

of Napoleon's Advanced Technology

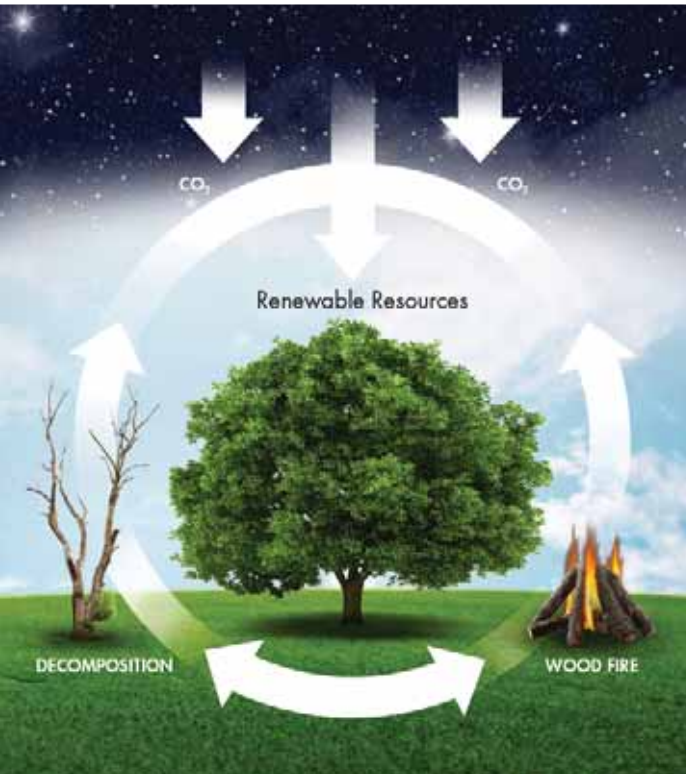

Help Protect The Environment With A Napoleon® Wood Burning Fireplace

Heating your home with a Napoleon® high efficiency, EPA (Environmental Protection Agency) approved fireplace, stove or insert releases no more carbon dioxide than a dying tree would lying on the forest floor. In fact, when the entire carbon cycle is considered, a Napoleon® EPA approved fireplace heats your home more efficiently and with less impact on the environment than any other heating fuel option.

Outstanding Craftsmanship

Fine details are designed in every aspect of Napoleon® fireplaces... individually handcrafted with pride of excellence.

WHISPER QUIET Heat Circulating Blower System

The extreme heat resistant "H" class bearings featured in Napoleon's superior heat circulating blower, creates a lasting "whole home" comfort with adjustable high & low speeds.

Secondary Air Tube - Kiln Construction

Napoleon's secondary air tube is insulated with ceramic fibre and protected with a stainless steel cover plate, ensuring complete combustion. This fully lined refractory firebox acts as a kiln, concentrating the maximum amount of heat to efficiently heat your home.

Solid Hinged Doors

Manufactured with heavy gauge steel, the doors are conveniently hinged on most models for easy opening.



High Country™ - NZ6000

Anatomy of the Perfect Fireplace

1. Combustion and dilution air is brought into the unit through the fresh air intake collars located on the bottom side of the unit.
2. The combustion air is brought into the firebox through many small holes in the airwash located at the side and top of the opening.
3. Safety switch, the blower stops automatically when door is open and starts again when door is closed.
4. A single air control regulates the burn rate.
5. Combustion takes place inside the firebox, smoke and gases are moved around a large baffle system into a second chamber for complete combustion and extended flame path to extract maximum amount of heat and exhausts out the chimney.
6. The optional blower provides an ideal means of circulating warm air within the home. Where location permits and extreme cold temperatures are not experienced, this blower may also be installed to utilize fresh outside air to introduce "positive pressure" to the home. The powerful 320 CFM blower can be installed remotely from the unit (ie. basement) so you can enjoy increased air circulation with WHISPER QUIET operation.
7. The optional hot air gravity vent system may be used to distribute heat to an adjoining room (located either above, or beside the room containing the fireplace).
8. Summer by-pass damper allows more heat to flow straight up the chimney so you can enjoy your fireplace even in the warmer months.
9. Heavy duty secondary air tube introduces just the right amount of air to increase efficiency through complete combustion.

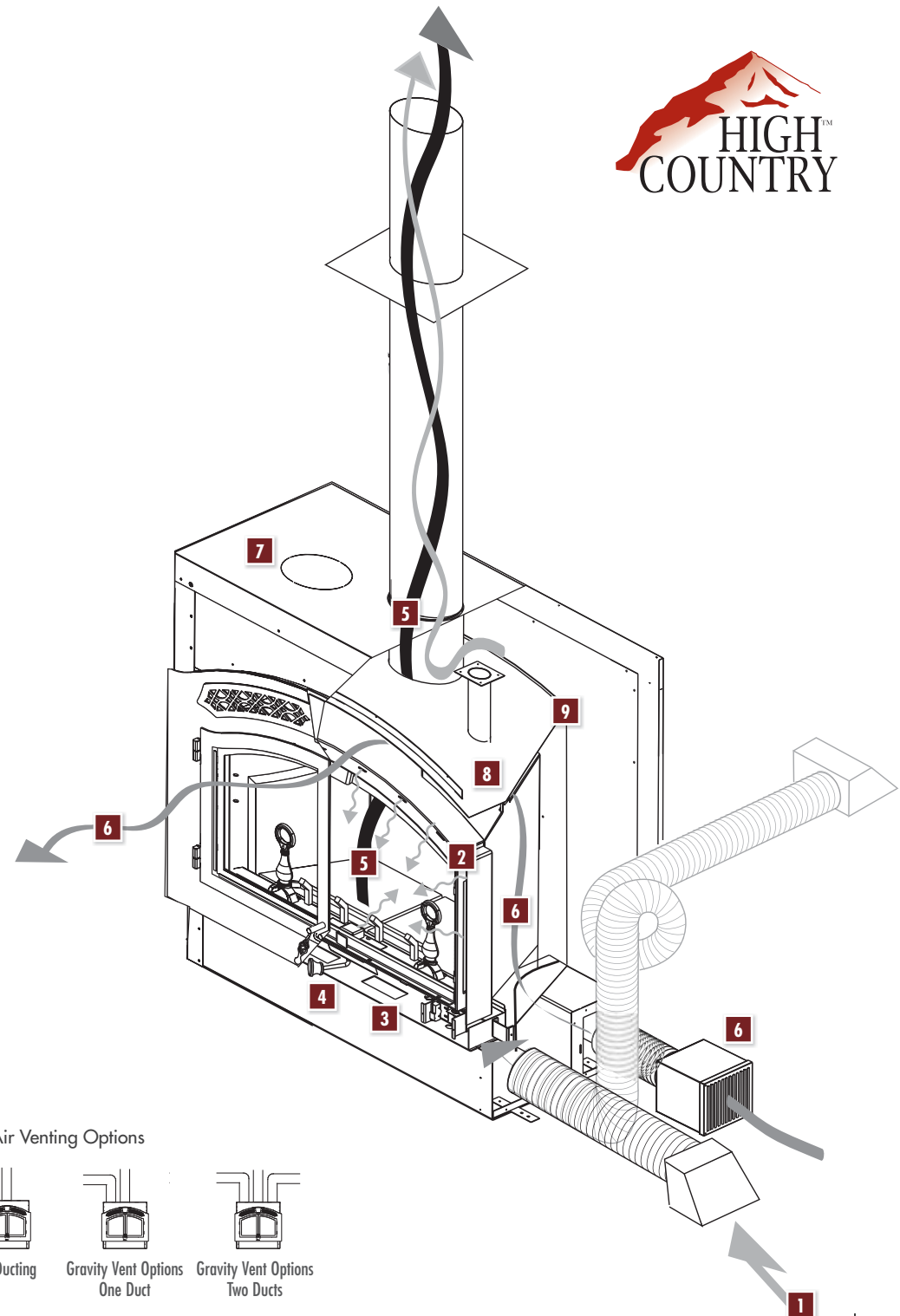

Approved with chimneys Any 8" diameter chimney listed to these standards may be installed. In accordance with these standards, the unit may also be connected to any chimney listed to CAN/ULC-S604 and CAN/ULC-S629 for Canada or UL-103HT for the United States.

Minimum Clearance to combustibles

Minimum, fireplace	"0" to stand offs (rear) 6" to sides
Ceiling to enclosure	120" from the base of the unit (unless shielded with metal studs and cement board)
Ceiling (in front of fireplace)	84" from the base of the unit
Chimney	2" (follow manufacturer's instructions)
Hot air gravity duct work	1"
Mantle to top of faceplate	from 12" (with mantel protruding 2") to 18" (with mantel protruding 8")
Minimum hearth extension	20" x 61 1/2" non-combustible surface

Hot Air Venting Options

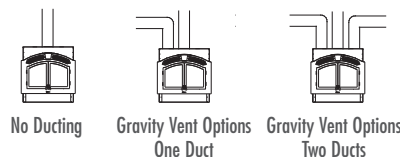



High Country™ - NZ3000

Anatomy of the Perfect Fireplace

1. Combustion air is brought into the unit through the fresh air intake collar located on the bottom side of the unit.
2. Heavy duty secondary air tubes introduce just the right amount of air to increase efficiency through complete combustion.
3. Combustion takes place inside the firebox, smoke and gases are moved around a large baffle system into a second chamber for complete combustion and extended flame path to extract maximum amount of heat and exhausts out the chimney.
4. The optional hot air gravity central heating vent system may be used to distribute heat to an adjoining room (located either above or beside the room containing the fireplace).
5. The optional blower provides an ideal means of circulating warm air within the home. Where location permits and extreme cold temperatures are not experienced, this blower may also be installed to utilize fresh outside air to introduce "positive pressure" to the home. The powerful 320 CFM blower can be installed remotely from the unit (ie. basement) so you can enjoy increased air circulation with WHISPER QUIET operation.
6. Radiant Heat
7. A single air control regulates the burn rate.
8. High Heat Ceramic Glass
9. Cool room air circulates around the firebox and is pushed back out into the room for additional heat.
10. Fully insulated outershell to reduce clearances.
11. Two piece, high density ceramic, removable baffle allows easy access for chimney cleaning and maintenance.

Approved with chimneys

Any 7" or 8" diameter chimney listed to these standards may be installed. In accordance with these standards, the unit may also be connected to any chimney listed to CAN/ULC-S604 and CAN/ULC-S629 for Canada or UL-103HT for the United States.

Minimum Clearance to combustibles

Minimum, fireplace	"O" to stand offs (rear) 6" to sides
Ceiling to enclosure	84" from the base of the unit
Ceiling (in front of fireplace)	84" from the base of the unit
Chimney	2" (follow manufacturer's instructions)
Hot air gravity duct work	1"
Mantle to top of faceplate	from 12" (with mantel protruding 2") to 18" (with mantel protruding 8")
Minimum hearth extension	20" x 54" non-combustible surface

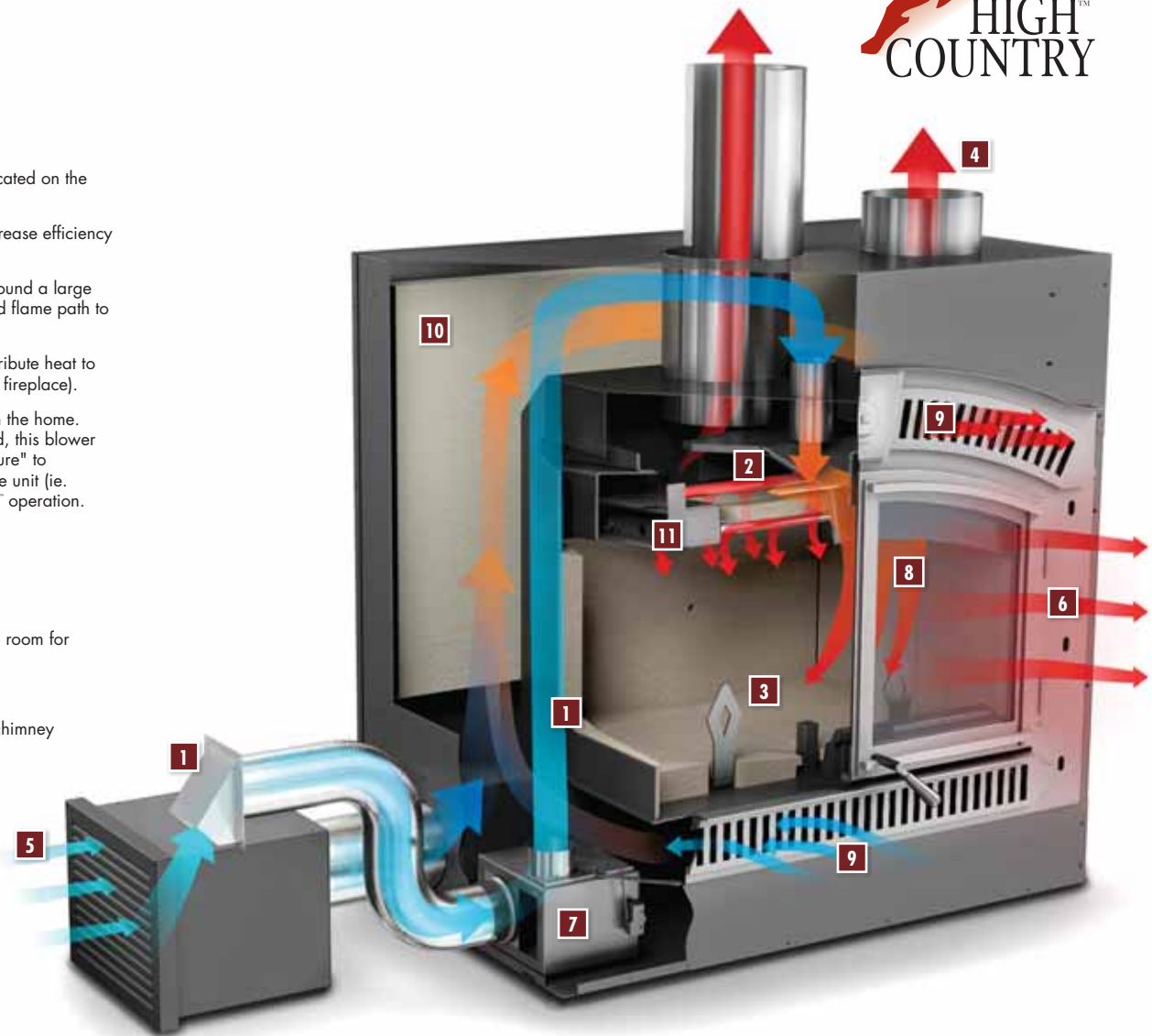

Hot Air Venting Options



No Ducting

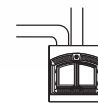

Gravity Vent Options
One Duct

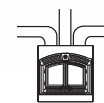

Gravity Vent Options
Two Ducts

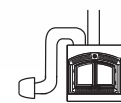

Central Heating

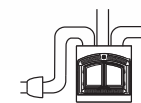

Central Heating
& Gravity Vent Option

NZ-26 - Prestige®

Anatomy of the Perfect Fireplace

Install as a zero clearance fireplace with a factory built chimney or as a masonry fireplace using an existing or new masonry chimney.

Four different heating usage options:

1. Standard installation heats through natural convection
2. Gravity, hot air vent system to heat adjoining rooms
3. Central system with thermostatic control for multi-room heating
4. Thermostatically controlled system connects to existing duct work

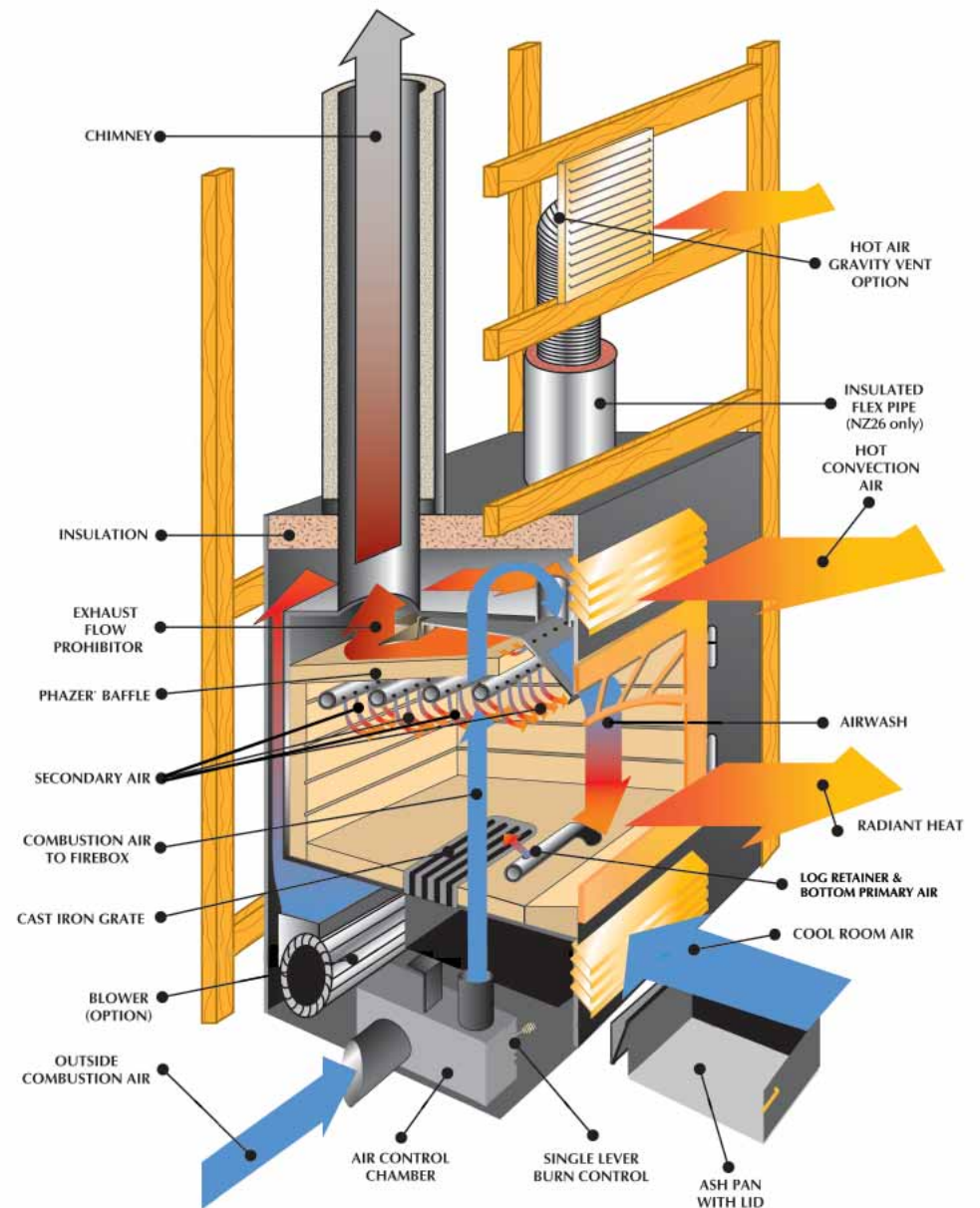

Approved with chimneys

Any 6" diameter chimney listed to these standards may be installed. In accordance with these standards, the unit may also be connected to any chimney listed to CAN/ULC-S604 and CAN/ULC-S629 for Canada or UL-103HT for the United States.

Minimum Clearance to combustibles

Minimum, fireplace	"0" to stand offs (rear) 6" to sides
Ceiling of enclosure	72" from the base of the unit (unless shielded with metal studs and cement board)
Ceiling (in front of fireplace)	72" from the base of the unit
Chimney	2" (follow manufacturer's instructions)
Hot air gravity duct work	1"
Mantle to top of faceplate	from 24" (with mantel protruding 2") to 30" (with mantel protruding 8")
Minimum hearth extension	16" x 50" non-combustible surface

Hot Air Venting Options

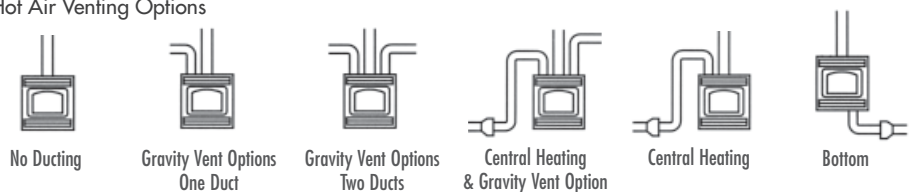



Arched Faceplate,
Doors, Grill & Keystone
Wrought Iron Finish (NZ6000)



Arched Faceplate,
Doors, Grill & Keystone
Painted Black Finish (NZ6000)



Arched Faceplate,
Doors, Grill & Keystone
Satin Chrome Plated Finish (NZ6000)



Arched Doors,
Grill & Keystone
24 Karat Gold Plated Finish (NZ6000)



Arched Faceplate,
Doors, Grill & Keystone
Wrought Iron Finish (NZ3000)



Arched Faceplate
Modern Inset
Painted Black Finish (NZ3000)



Arched Faceplate
Heritage Pattern Inset
Painted Black Finish (NZ3000)

Andirons

Designed to simply stand in front of the logs and give the optimum traditional masonry look and feel.



Louvres



Painted Black Finish



Brushed Stainless Steel Finish



24 Karat Gold Plated Finish



Polished Brass Finish

Doors



Painted Black Finish



Satin Chrome
Plated Finish



24 Karat Gold
Plated Finish



Painted Black Finish



Satin Chrome
Plated Finish



24 Karat Gold
Plated Finish



Door Inlays

In addition to its original wrought iron faceplate and doors, you can now also choose cast iron doors without trim or with a brushed stainless steel or brushed copper inlay.



Arched Screen Kits

Optional screen kits allow operation of unit when heat is not abundantly required and promotes an open fire experience.



Spring Door Handles

Spring door handles are available in 24 Karat gold plated, satin chrome plated or painted black finishes.



Country Crane and Hearth Pot

Designed specifically to add to the look and feel of the NZ6000 wood burning fireplace.

	NZ6000	NZ3000	NZ3000
Louvres (painted black, polished brass, satin chrome plated and 24 Karat gold plated finishes)	-	-	0
Arched Faceplate complete with Upper Grill & Keystone (wrought iron finish)	0	0	-
Arched Faceplate (painted black finish)	0	0	-
Arched Faceplate (satin chrome plated finish)	0	-	-
Arched Double Doors (24 Karat gold plated finish)	0	-	-
Arched Double Doors (wrought iron finish)	0	0	-
Arched Double Doors (painted black finish)	0	0	-
Arched Double Doors (satin chrome plated finish)	0	0*	-
Arched Double Doors (brushed copper plated finish)	-	0	-
Arched Upper Grill (painted black finish)	0	-	-
Arched Upper Grill (satin chrome plated finish)	0	-	-
Arched Upper Grill (24 Karat gold plated finish)	0	-	-
Keystone (painted black finish)	0	-	-
Keystone (satin chrome plated finish)	0	-	-
Keystone (24 Karat gold plated finish)	0	-	-
Modern Inset (painted black finish)	-	0	-
Heritage Pattern Inset (painted black finish)	-	0	-
Webbed Arched Door (painted black, satin chrome plated and 24 Karat gold plated finishes)	-	-	0
Arched Door (painted black, satin chrome plated and 24 Karat gold plated finishes)	-	-	0
Spring Door Handle (painted black, satin chrome plated and 24 Karat gold plated finishes)	-	-	0
Cast Iron Surround Kit (painted black finish)	-	-	0
Andirons (painted black finish)	S	S	-
Arched Screen Kit	0	0	-
Country Crane & Hearth Pot	0	-	-
Cast Iron Grate	S	S	-
Napoleon® Insignia	S	-	-
Ceramic PHAZER® Baffle	-	-	S
Ash Pan with Lid	-	-	S
Blower Kit	0	0	0
Central Heating System Kit	-	-	0
Gravity Hot Air Vents	0	0	0

S - Standard O - Optional *Brushed satin chrome plated finish for NZ3000

NZ6000 - High Country™

Shown on pages 4 & 5

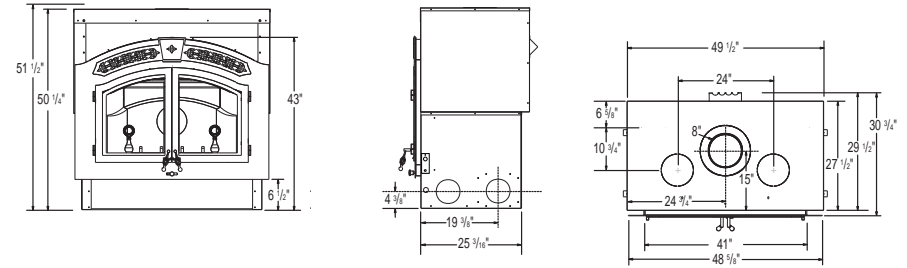
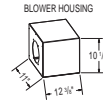

Model	BTU's Heat Output*	BTU's Heat Output (High Burn)**	Firebox Capacity (cu. ft.)	Area Heated (sq. ft.)	Burn Time (Hours)	Log Size (Max)	Emmissions (Grams Per Hour)	Flue Diameter	Outside Air for Combustion	Mobile Home Approved	Central Heating and/or Blower	Glass Size (x2)		Weight of Bricks	Weight without Bricks
												Width	Height		
NZ6000	10,000 - 80,000	100,000+	4.8	3000+	14	32"	N/A	8"	Yes	No	Optional	16 3/8"	21 3/8"	110 lbs	583 lbs

Tested and listed by Intertek Testing Services Ltd. as per North American standards: ULC S610, UL 127 for factory built fireplaces.

NZ3000 - High Country™

Shown on pages 6 & 7

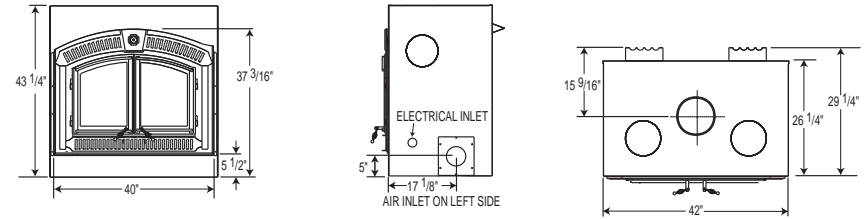

Model	BTU's Heat Output*	BTU's Heat Output (High Burn)**	Firebox Capacity (cu. ft.)	Area Heated (sq. ft.)	Burn Time (Hours)	Log Size (Max)	Emmissions (Grams Per Hour)	Flue Diameter	Outside Air for Combustion	Mobile Home Approved	Central Heating and/or Blower	Glass Size (x2)		Weight of Bricks	Weight without Bricks
												Width	Height		
NZ3000	10,000 - 40,000	60,000	2.78	2000+	12	25"	7.3	7"	Yes	No	Optional	12 1/2"	17"	128 lbs	352 lbs

Tested and listed by Intertek Testing Services Ltd. as per North American standards: CAN/ULC S610, UL 127 for factory built fireplaces and to ULC S639 for steel liner assemblies for solid fuel burning masonry fireplaces.

NZ-26 - Prestige®

Shown on pages 8 & 9

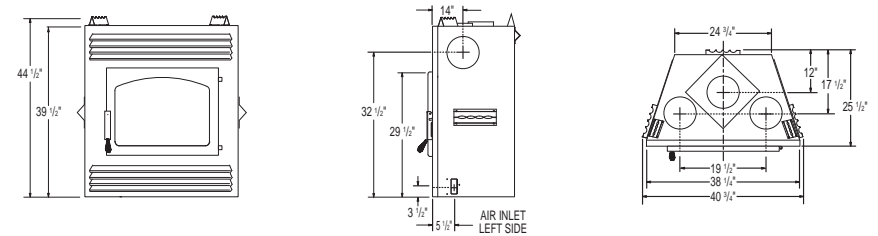

Model	BTU's Heat Output*	BTU's Heat Output (High Burn)**	Firebox Capacity (cu. ft.)	Area Heated (sq. ft.)	Burn Time (Hours)	Log Size (Max)	Emmissions (Grams Per Hour)	Flue Diameter	Outside Air for Combustion	Mobile Home Approved	Central Heating and/or Blower	Glass Size		Weight of Bricks	Weight without Bricks
												Width	Height		
NZ26	11,500 - 27,400	70,000	1.7	2000	9	18"	5.4	6"	Yes	Yes†	Optional	16"	24 1/4"	132 lbs	262 lbs

Tested and listed by Intertek Testing Services Ltd. as per North American standards: CAN/ULC S610, UL 127, for Zero Clearance fireplaces, and to ULC S639 for steel liner assemblies for solid fuel burning masonry fireplaces.

†USA only
 Figures may vary with individual conditions such as floor plan layout, insulation value of the home and the firewood used

*EPA (Environmental Protection Agency) rated BTU/h with softwood test fuel (for emissions only) - no refueling
 **Wolf Steel Ltd. own test results showing realistic BTU's using hardwood logs with regular refueling. Heat output will differ on chimney draft as well as type, moisture content and size of wood.

Other Napoleon® Products



Fireplace Inserts • Charcoal Grills • Gas Fireplaces • Waterfalls • Wood Stoves
 Hybrid Furnaces • Electric Fireplaces • Heating & Cooling • Gourmet Grills



24 Napoleon Road, Barrie, Ontario, Canada L4M 0G8
 103 Miller Drive, Crittenden, Kentucky, USA 41030
 7200 Trans Canada Highway, Montreal, Quebec, Canada H4T 1A3

Tel: 705-721-1212 Fax: 705-722-6031
napoleonfireplaces.com



Authorized Dealer

Napoleon stoves are certified for emissions to EPA phase 2 1990 and DEQ 1988 Standards and safety tested by Warnock Hersey to North American Standards. CSA B366.2, ULC S610, ULC S627, ULC S629 and UL 127. In addition to meeting current EPA requirements, all Napoleon® wood burning stoves and Inserts with emissions at or below 4.5 grams per hour meet the proposed new EPA clean burning levels targeted for implementation in 2013. Consult your owner's manual for complete installation instructions and check all local and national building codes. All specifications and designs are subject to change without notice to allow for on-going product improvement. Images may not be exactly as shown. Actual enamel colours might be slightly different as shown in brochure. © Wolf Steel Ltd. Napoleon® is a registered trademark of Wolf Steel Ltd.