



NAPOLEON

# Prestige<sup>®</sup> Collection

Direct Vent  
Gas Fireplaces



QUALITY FIREPLACES

# N A P O L E O N

*The Comfort You Deserve*

With over 35 years of passionate dedication, Napoleon®, an industry leader for innovative designs, has earned a worldwide reputation for providing families with fireplaces of uncompromising quality, state-of-the-art technology and designer features that create a proud statement in any home.

As the largest family owned hearth manufacturer in North America, Napoleon® holds strong family values that carry through in every aspect of the organization. Since 1976, Napoleon® has grown from a small manufacturing operation to a large private corporation, instilling the same strong values they started with. Napoleon® products are found in homes around the globe... becoming the preferred choice worldwide.



# WHY NAPOLEON?

## **Making your life easier...**

Napoleon's Prestige® Collection is designed to provide you absolute comfort and control at the touch of your fingertips. It's that easy. When you install a Napoleon® direct vent gas fireplace, you can rest assured that you will enjoy a lifetime of instant ambiance with reliable performance year after year.

---

## **An investment you can count on...**

Your new Napoleon® fireplace adds value to your home while at the same time giving you uncompromising comfort and a reliable heating source. Aside from kitchen and bathroom renovations, fireplaces add the most return on your home investment. Nothing to lose and everything to gain.

---

## **The next generation of fireplace design...**

Surround yourself with a home environment that makes you feel good, relaxed and proud to reflect your decorating style. Thousands of designer options are available to create the exact statement you have been looking for. Visit [napoleonfireplaces.com/FDS](http://napoleonfireplaces.com/FDS) to design, visualize and price the perfect fireplace for your home.

---

## **Highest efficiencies, maximum comfort...**

Years of research, design and testing have enhanced optimum performance allowing Napoleon® products to achieve some of the highest heater rating efficiencies on the market. Napoleon® continuously surpasses industry standards not only in appearance but in efficiency and performance.

---

## **Beautiful fires, best flame in the industry...**

With advanced burner technology and innovative design, Napoleon's flame and exclusive PHAZER® log sets are so realistic it's hard to tell the difference from a real wood burning fire.

---

## **Authorized dealer support network...**

With over 3,000 reputable authorized dealers across North America and Europe, Napoleon® provides professional and consistent training and technical support to ensure your fireplace is installed by a certified, reputable installation technician.

---

## **Outstanding Reliable Warranty...**

Each and every Napoleon® fireplace is designed and manufactured to strict quality testing standards and backed by the President's Limited Lifetime Warranty, guaranteed to give you the solid performance you deserve. (Registered under the world recognized ISO 9001-2008)

---

## **Mantel Selection...**

Napoleon® offers a complete selection of wood and architectural cast stone mantel packages. Ask your dealer for details or view online at [napoleonfireplaces.com](http://napoleonfireplaces.com).

 Only Napoleon® offers you these exclusive features. Watch for this symbol throughout the brochure.



**QUALITY FIREPLACES**

[napoleonfireplaces.com](http://napoleonfireplaces.com)

Napoleon® Waterfall Collection  
& Outdoor Living Products - Creating  
A Healthy, Relaxing Atmosphere

Napoleon® Architectural Cast Stone  
Mantels - Surrounding Yourself With  
Natural Beauty

(Background tile available through local tile outlets)

Napoleon® Quality Fireplaces,  
Inserts & Stoves - Instant Comfort  
& Ambiance







STARfire™ shown with painted black decorative faceplate complete with operable safety screen doors and Napoleon's 3'x6' waterfall also shown.

# The Dream™

## Napoleon® Exclusive Features

- 🔥 • Exclusive Napoleon® NIGHT LIGHT™ radiates a warm glow to the room even when the fireplace is off
  - 🔥 • An unbelievable 16 sq. ft. viewing area - One of the largest in the industry
  - 🔥 • Double burner system showcasing two incredible levels of intense YELLOW DANCING FLAMES™
  - 🔥 • Exclusive PHAZER™ logs with a natural wood appearance
- Traditional clean face masonry design and feel
  - 50% flame/heat adjustment for maximum comfort and efficiency
  - Millivolt system ensures reliable use even during power failures
  - 100% SAFE GUARD™ gas control system automatically and quickly shuts off the gas supply for your peace of mind
  - Zero clearance to combustibles
  - Convenient thermostatic remote (controlling blower, flame intensity, temperature and NIGHT LIGHT™)
  - Exquisite Sandstone Herringbone decorative brick panels
  - Solid cast iron decorative andirons in painted black included with the unit
  - Controls are concealed from view but easily accessible
  - Available as a natural gas or propane unit
  - Optional solid wrought iron decorative square frame with arched rail inset
  - Optional solid wrought iron rectangular “Artisan” double doors
  - Optional remote blower kit for WHISPER QUIET™ operation
  - Optional country crane and hearth pot
  - Approved for bathrooms, bedrooms, bed sitting rooms and mobile homes
  - Backed by President's Lifetime Limited Warranty

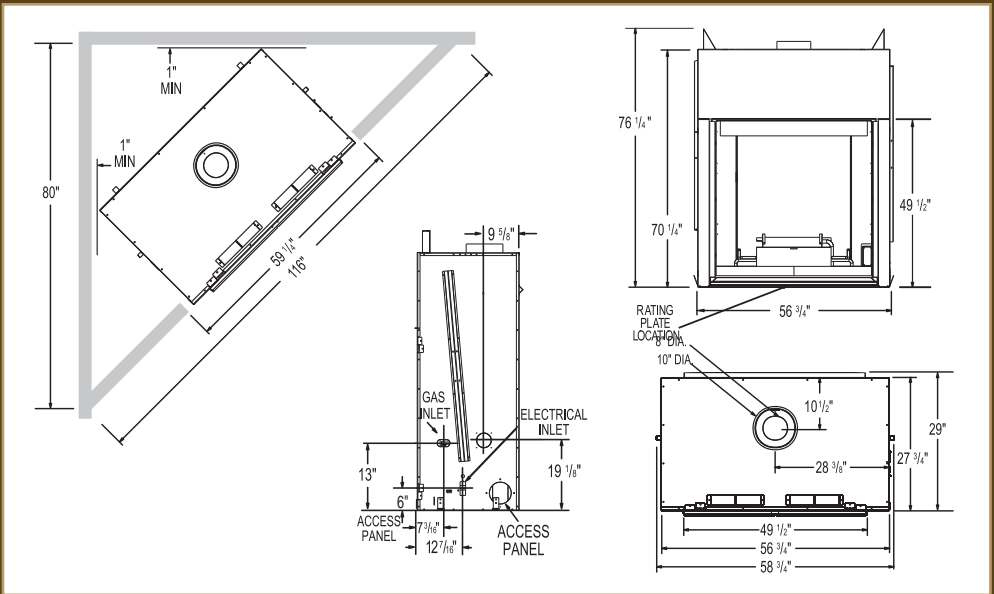

Napoleon® Exclusive Feature

Model	BTU'S (Input)		Venting 8" & 10"	Height		Front Width		Depth	
	Natural Gas	Propane		Actual	Framing	Actual	Framing	Actual	Framing
BGD90	50,000	50,000	Top	49 1/2"	76 1/2"	56 3/4"	59 1/4"	27 3/4"	29 1/2"

Model	Glass Type	Glass Size		Efficiencies			Blower	Mobile Home Certified
		Height	Width	EnerGuide	AFUE	Steady State		
BGD90	Tempered	49 1/2"	49 1/2"	63%	54%	63%	Optional	Yes

Certified under Canadian and American National standards CSA 2.22, ANSI, Z21.50 for vented gas fireplaces.  
Consult your owner's manual for complete and up-to-date installation instructions and proper clearances to combustible materials.

## Optional Decorative Accessories



Optional solid wrought iron decorative square frame with arched rail inset



Optional solid wrought iron rectangular "Artisan" double doors



Optional country crane and hearth pot



### Remote Control

(Included)



### Dual NIGHT LIGHT™

(Included)





# The Dream™ BGD90

*Everything you've dreamed of and more...*



Shown with standard Sandstone Herringbone brick panels and andirons

Modulating thermostatic remote control included

This colossal fireplace has the phenomenal viewing area of 16 square feet, sure to capture anyone's attention who may enter the room. With its astounding design, the Dream™ is the perfect fireplace to make a statement in any home. Ideal for a great room, large bedroom, ski lodge, lobby or castle. Napoleon® is extremely pleased to offer such an extraordinary fireplace for discriminating customers who want to set themselves apart.







# HD81 See Thru

## Napoleon® Exclusive Features

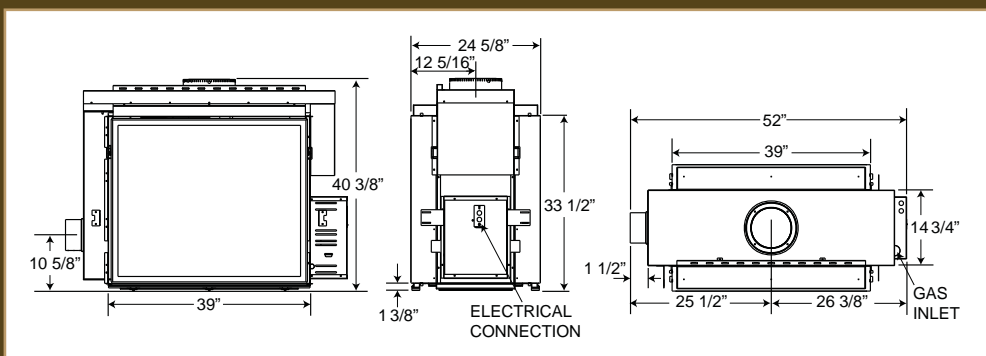
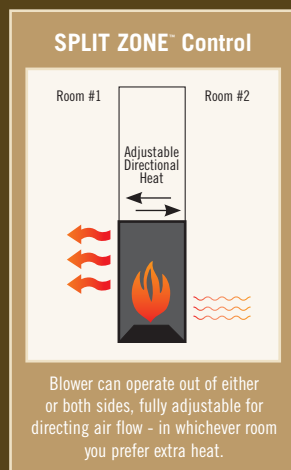
- Exclusive Napoleon® NIGHT LIGHT™ radiates a warm glow to the room even when the fireplace is off
  - Innovative, split burner system produces beautiful YELLOW DANCING FLAMES™ and provides a huge heating range from 22,000 BTU's to 60,000 BTU's
  - Optional quiet, remote, high output blower system pushes the heat out from above the door openings with SPLIT ZONE™ control - see diagram
  - Choice of Napoleon's traditional PHAZER® logs, CRYSTALINE™ crystals or River Rock ember beds
  - Exclusive anti-condensation switch (ACS)
- See Thru, clean face design can be enjoyed from two separate rooms
  - Fuel saving electronic ignition
  - Convenient remote, controlling the flame, blower and dual NIGHT LIGHT™ comes standard with the unit
  - Perfect for residential or commercial use
  - Topaz glass comes standard with CRYSTALINE™ ember bed - optional coloured glass is available
  - Available in natural gas or propane
  - Optional Porcelain Reflective Radiant Panels or decorative Sandstone brick panels are available
  - Optional Power Vent kit makes difficult installation locations possible with added flex vent and termination versatility
  - Optional polished chrome burner accent trim (CRYSTALINE™ and rock burner only)
  - Certified for bathrooms, bedrooms, bed sitting rooms and mobile homes
  - Backed by President's Lifetime Limited Warranty



 Napoleon® Exclusive Feature

Model	BTU'S (Input)		Venting 8" & 10"	Height		Front Width		Depth	
	Natural Gas	Propane		Actual	Framing	Actual	Framing	Actual	Framing
HD81	60,000	50,000	Top	33 1/2"	49 1/4"	39"	54 3/4"	24 5/8"	23 5/8"

Model	Glass Type	Glass Size		Efficiencies			Blower	Mobile Home Certified
		Height	Width	EnerGuide	AFUE	Steady State		
HD81	Ceramic	30 3/4"	36 3/4"	65%	68 %	67%	Optional	Yes

Certified under Canadian and American National standards: CSA 2.33, ANSI Z21.88 for vented gas fireplace heaters. Consult your owner's manual for complete and up-to-date installation instructions and proper clearances to combustible materials.

## Firebox Options



PHAZER® log set



Contemporary CRYSTALINE™ setting shown with clear glass



Contemporary River Rock setting

## Decorative Panels



Sandstone Brick



**MIRRO-FLAME™**  
Porcelain Reflective  
Radiant Panels

## Coloured Glass Options



Amber



Black



Blue



Red



Clear



Topaz  
(standard)

## NIGHT LIGHT™



Exclusive NIGHT LIGHT™

## Andirons



Painted Black Andirons

## Burner Trim



Polished Chrome  
Accent Trim



HD81 See Thru

*One fireplace, two rooms, exceptional views*



Modulating thermostatic  
remote control included

HD81 shown with log burner configuration and black bevelled trim

The HD81 is the first See Thru direct vent fireplace in the industry to offer such dynamic choices for firebox design options. Besides supplying two rooms with exceptional focal points, the HD81 also offers the choice of a traditional PHAZER® log set, a modern crystal ember bed or glowing river rock setting. Any of these 3 design choices create an exciting environment for any home.





# The Madison™

## Napoleon® Exclusive Features

- **Exclusive Napoleon® NIGHT LIGHT™** radiates a warm glow to the room even when the fireplace is off
  - **PHAZERAMIC™** advanced burner technology with glowing ember bed produces the most realistic flames in the industry
  - **Efficient Heat Exchanger;** Napoleon's exclusive heat catalyzing chamber draws cool room air in, forcing it around the entire hot firebox and back out in the room with a high output heat circulating blower system, standard with every Madison™
- Immense 37" w x 30" h viewing area
  - Available in either a true arch or rectangular design opening
  - Realistic PHAZER® logs, distinctive to the Madison™, provide real wood log appearance
  - 100% SAFE GUARD™ gas control system automatically and quickly shuts off the gas supply for your peace of mind
  - 50% flame/heat adjustment for maximum comfort and efficiency
  - Superior heat circulating blower with variable speed control provides a powerful heating performance
  - Elegant cast iron andirons & grate come standard with the unit
  - Full view operable safety screen
  - Modulating thermostatic remote (controls flame, heat, blower and NIGHT LIGHT™) comes standard with the unit
  - No electricity required to light or operate - millivolt system ensures reliable use even during power failures
  - Available as a natural gas or propane unit
  - Approved for bathrooms, bedrooms, bed sitting rooms and mobile homes
  - Backed by President's Lifetime Limited Warranty

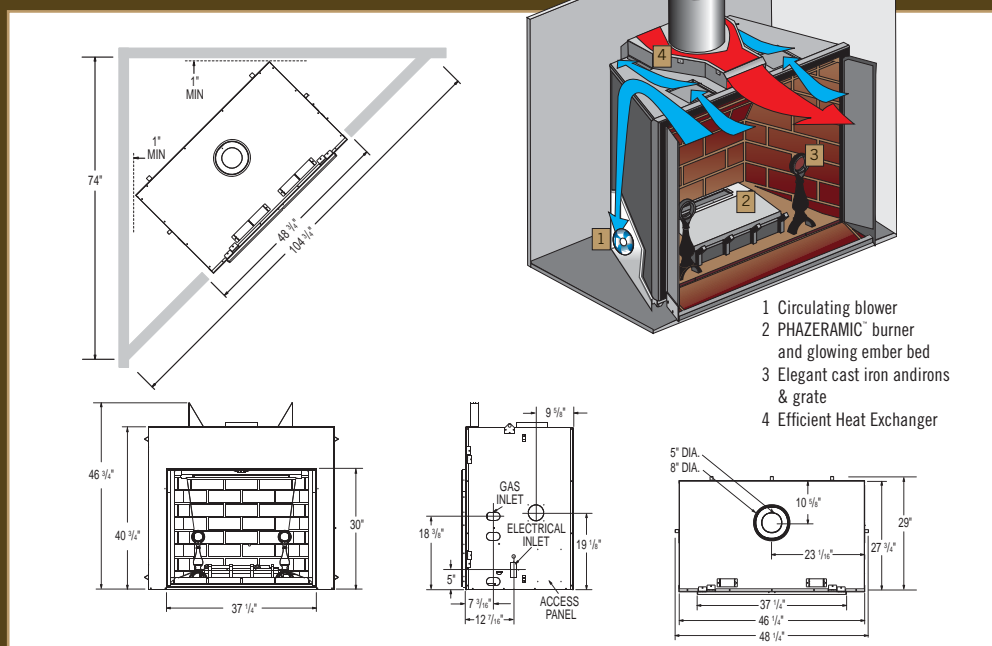

Napoleon® Exclusive Feature

Model	BTU'S (Input)		Venting 5" & 8"	Height		Front Width		Depth	
	Natural Gas	Propane		Actual	Framing	Actual	Framing	Actual	Framing
GD80	43,000	43,000	Top	40 3/4"	47"	46 1/4"	48 3/4"	27 3/4"	29 1/4"

Model	Glass Type	Glass Size		Efficiencies			Blower	Mobile Home Certified
		Height	Width	EnerGuide	AFUE	Steady State		
GD80	Ceramic	30"	37"	51.4%	-	78%	Included	Yes

Certified under Canadian and American National standards: CSA 2.22b, ANSI Z21.50 for vented gas fireplace heaters. Consult your owner's manual for complete and up-to-date installation instructions and proper clearances to combustible materials.

# Optional Door Kits



Hand-forged iron - solid handcrafted wrought iron faceplate complete with double arched doors



Arched Hammertone Copper Finish Door



Arched Hammertone Pewter Finish Door



Rectangular Hammertone Copper Finish Door



Rectangular Hammertone Pewter Finish Door

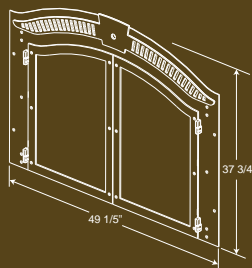
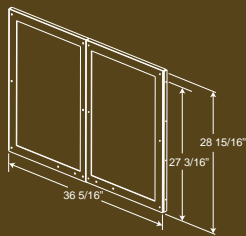
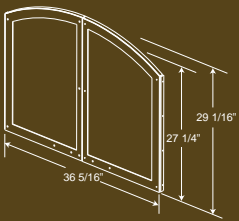

## Decorative Panels



Sandstone Herringbone Brick



Old Town Red<sup>™</sup> Brick



Sandstone Brick



**MIRRO-FLAME<sup>™</sup>**  
Porcelain Reflective Radiant Panels

## Decorative Frames

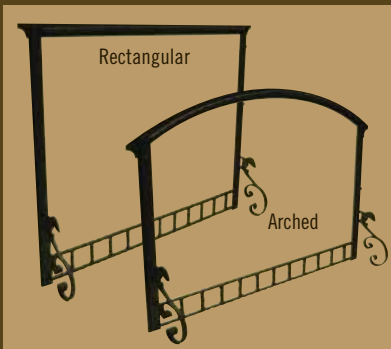

# The Madison™ GD80

*Old world charm... With tomorrow's technology*



Modulating thermostatic remote control included

Shown with Old Town Red™ brick panels





The Madison™ rekindles the romantic era when sitting by the fire melted away the chills of the world outside. The traditional aesthetics provide an exceptional, unobstructed viewing area with a frameless finish. An open look of a real wood burning fireplace emerges with all the conveniences of direct vent technology. This exclusive fireplace comes fully equipped with a multi-function hand-held remote control (adjusting flame, heat, blower and exclusive NIGHT LIGHT™), elegant solid cast iron andirons and grate, heat circulating blower, safety pull screen and advanced burner technology. All this and the choice of either a wrought iron faceplate or a traditional arch or rectangular door design to complement your décor.







# Clean Face High Definition Fireplace

## Napoleon® Exclusive Features

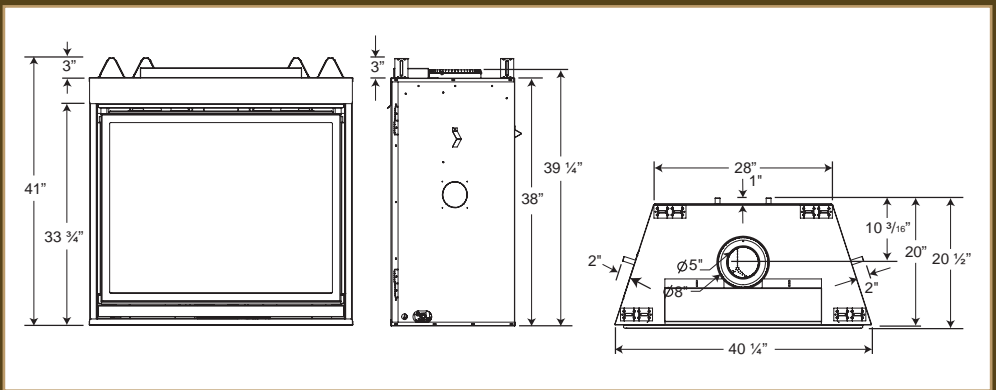
-  • Up to 40,000 BTU's
  -  • 54% flame/heat adjustment for maximum comfort and efficiency
  -  • Fuel saving electronic ignition with battery back-up and built-in adjustable flame/ heat control
  -  • Exclusive NIGHT LIGHT™ feature comes standard with the unit
- Your choice of exquisite, fine detailed PHAZER® logs and charcoal embers or a stunning river rock media tray with satin chrome decorative fender
  - Media enhancement kits of coloured glass (amber, blue, black, red, clear and topaz) are designed to enhance the river rock firebox base
  - Four-sided frame is available in painted black, brown or diamond dust pewter
  - Faceplate with operable screen doors is available in wrought iron finish
  - Solid wrought iron door frame and trim with a detailed arched design is available
  - An impressive Newport™ decorative brick panel or a Mayan Desert Sandstone brick panel add to the traditional design
  - Porcelain Reflective Radiant Panels are available in flat or ribbed design
  - Bevelled trim kit is available in painted black or brushed stainless steel finish
  - Andirons available in painted black
  - Convenient on/off or thermostatic remote controls available
  - Available in natural gas or propane
  - Certified for bedrooms, bathrooms, bed sitting rooms and mobile homes
  - President's Limited Lifetime Warranty



 Napoleon® Exclusive Feature

Model	BTU'S (Input)		Venting 5" & 8"	Height		Front Width		Depth	
	Natural Gas	Propane		Actual	Framing	Actual	Framing	Actual	Framing
HDX40	40,000	36,000	Top	33 3/4"	46 1/4"	40 1/4"	44 3/4"	20"	20 1/4"

Model	Glass Type	Glass Size		Efficiencies			Blower	Mobile Home Certified
		Height	Width	EnerGuide	AFUE	Steady State		
HDX40	Ceramic	28"	36"	56.6%	59.5%	61.5%	Optional	Yes

Certified under Canadian and American National standards: CSA 2.33, ANSI Z21.88 for vented gas fireplace heaters. Consult your owner's manual for complete and up-to-date installation instructions and proper clearances to combustible materials.

## Alternate Media Kit



River Rock  
Media Tray with  
Satin Chrome  
decorative fender

## Media Enhancement Kits

Designed to enhance the river rock firebox base



Amber  
Glass



Blue  
Glass



Black  
Glass



Red  
Glass



Clear  
Glass



Topaz Glass  
(standard)

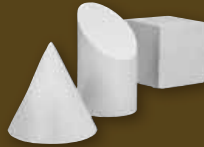

Ceramic  
GEO shapes

## Decorative Faceplates and Doors



Black faceplate  
with operable screen doors



Wrought iron faceplate  
with scalloped door

## Four-Sided Surrounds



Black Finish



Brown Finish

Diamond Dust  
Pewter Finish



## Bevelled Trims



Painted  
Black

Brushed  
Stainless steel



## Decorative Panels



Decorative  
Sandstone Brick



Mayan Desert™  
Sandstone Brick

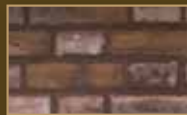

Newport™ Brick



**MIRRO-FLAME™**  
Porcelain Reflective  
Radiant Panels



**MIRRO-FLAME™**  
Ribbed Porcelain  
Radiant Reflective  
Panels

## Andirons



## Remote Controls

Digital read out and thermostatic control at the touch of a button. The optional F50 remote is available in three stylish designer colours - red, grey and black.



Clean Face High Definition HDX40

*Traditional, Classic, Inspired Design*



Shown with premium scalloped face trim & door and Newport™ decorative brick panels

Inspired by traditional masonry details and created with Napoleon's state-of-the-art gas fireplace technology, the deluxe HDX40 offers the ultimate in performance and design. The clean face front allows a full view of the impressive 40" wide firebox with your choice of either fine detailed PHAZER® logs and charcoal embers or a River Rock ember bed. The exclusive NIGHT LIGHT™ accents the firebox even when the fireplace is off. A perfect investment for your lifestyle and your home.



**QUALITY FIREPLACES**



# The STARfire™

## Napoleon® Exclusive Features

- Exclusive Napoleon® NIGHT LIGHT™ radiates a warm glow to the room even when the fireplace is off
- PHAZERAMIC™ advanced burner technology with glowing ember bed produces the most realistic flames in the industry
- Realistic PHAZER® logs, rich in colour and detail, provide a real wood log appearance
- 50% flame/heat adjustment for maximum comfort and efficiency
- 100% SAFE GUARD™ gas control system automatically and quickly shuts off the gas supply for your peace of mind
- Superior heat circulating blower with variable speed and thermostatic control provides powerful heating performance
- Available as a natural gas or propane unit
- Approved for bathrooms, bedrooms, bed sitting rooms and mobile homes
- Backed by President's Limited Lifetime Warranty



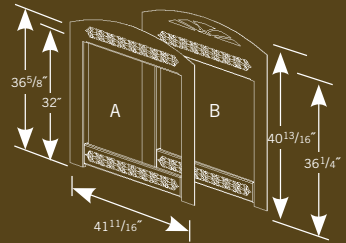

### Optional Decorative Faceplates

- A Ornamental faceplate designed for marble/ tile backing available in painted black  
 B Ornamental faceplate designed for flush wall installation available in painted black

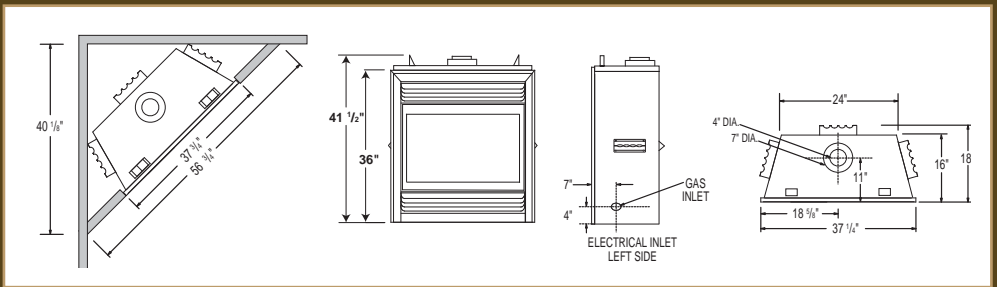
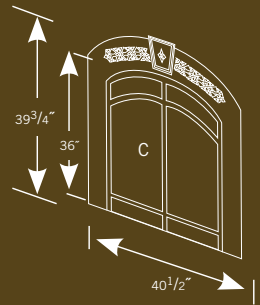

- C Decorative faceplate complete with operable safety screen doors available in painted black, hammertone copper and hammertone pewter.



 Napoleon® Exclusive Feature

Model	BTU'S (Input)		Venting 4" & 7"	Height		Front Width		Depth	
	Natural Gas	Propane		Actual	Framing	Actual	Framing	Actual	Framing
GD70	35,000	33,000	Top	36"	41 3/4"	37 1/4"	37 3/4"	16"	18 1/4"

Model	Glass Type	Glass Size		Efficiencies			Blower	Mobile Home Certified
		Height	Width	EnerGuide	AFUE	Steady State		
GD70	Ceramic	23"	31 5/8"	53.6%	65%	81%	Included	Yes

Certified under Canadian and American National standards: CSA 2.33 and ANSI Z21.88 for vented gas fireplace heaters. Consult your owner's manual for complete and up-to-date installation instructions and proper clearances to combustible materials.

# Optional Decorative Accessories

## Decorative Panels



Sandstone Herringbone Brick



Old Town Red™ Brick



Sandstone Brick



**MIRRO-FLAME™**  
Porcelain Reflective Radiant Panels



## Bayfront

Bay Front shown with painted black Heritage ornamental insets and cast iron surround. Fully operational safety fire screen for that masonry look and feel!

## Trims



3" bevelled trim available in textured painted black, antique brass finish, polished brass finish and brushed stainless steel finish



6" bevelled trim available in textured painted black, antique brass finish, polished brass finish and brushed stainless steel finish

## Doors



Painted Black



24 Karat Gold Plated



Brushed Stainless Steel Finish

## Remote Controls

Digital read out and thermostatic control at the touch of a button. The optional F50 remote is available in three stylish designer colours - red, grey and black.



## Heritage Ornamental Insets



Painted Black



24 Karat Gold Plated



Brushed Stainless Steel Finish

## Louvres



Painted Black



Antique Brass



Polished Brass



Brushed Stainless Steel

## Cast Iron Surrounds

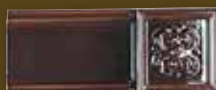

Porcelain Enamel Majolica Brown



Porcelain Enamel Black



Traditional Painted Black

## Andirons



Painted Black

24 Karat Gold Plated



# The STARfire<sup>®</sup> GD70

*Affordable luxury*



Modulating thermostatic remote control included

Shown with premium scalloped face trim & door and Old Town Red<sup>™</sup> brick panels.

The STARfire<sup>®</sup> offers you a wide range of heat output and control with a remarkable 50% flame/heat adjustment and an outstanding 81% efficiency rating. A 35,000 BTU burner provides cozy heat with stunning YELLOW DANCING FLAMES<sup>®</sup>. With a 682 square inch viewing area, the STARfire<sup>®</sup> is a one of a kind fireplace that you will be proud to show to family and friends! The perfect fit for great rooms and larger family rooms.





# The Park Avenue™

## Napoleon® Exclusive Features

- Exclusive Napoleon® NIGHT LIGHT™ radiates a warm glow to the room even when the fireplace is off
- PHAZERAMIC™ advanced burner technology with glowing embers provides the most realistic flame in the industry
- Available in natural gas or propane
- 50% flame/heat adjustment creates a perfect atmosphere with just the right amount of heat needed
- Your choice of exclusive designer accessories to suit any décor
- Multi-function remote, controlling the flame, blower & NIGHT LIGHT™, is included with the unit
- 100% SAFE GUARD™ gas control system automatically and quickly shuts off the gas supply for your peace of mind
- Superior heat circulating blower with variable speed provides powerful heating performance
- No electricity required to light or operate - millivolt system ensures use even during power failures
- Approved for use in bathrooms, bedrooms, bed sitting rooms and mobile homes
- Backed by President's Limited Lifetime Warranty



Living Rooms



Bedrooms



Bathrooms



Kitchens

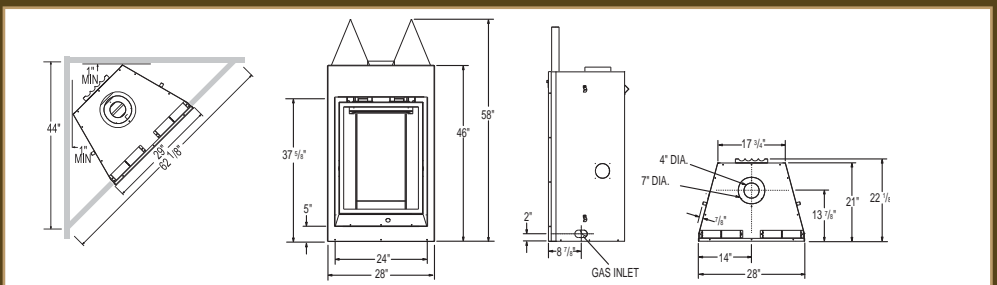

 Napoleon® Exclusive Feature

Model	BTU'S (Input)		Venting 4" & 7"	Height		Front Width		Depth	
	Natural Gas	Propane		Actual	Framing	Actual	Framing	Actual	Framing
GD82	26,000	26,000	Top	46"	58 1/4"	28"	29"	21"	22 1/2"

Model	Glass Type	Glass Size		Efficiencies			Blower	Mobile Home Certified
		Height	Width	EnerGuide	AFUE	Steady State		
GD82	Ceramic	28"	21"	55%	56%	62%	Included	Yes

Certified under Canadian and American National standards: CSA 2.33, ANSI Z21.88 for vented gas fireplace heaters. Consult your owner's manual for complete and up-to-date installation instructions and proper clearances to combustible materials.

## Arched Facing Kits



Arched facing kit with lattice pattern in hand-forged wrought iron



Arched facing kit with heritage pattern in painted black finish

## Brushed Stainless Steel Surround & Hearth



Napoleon's Brushed Stainless Steel surround and hearth

## Optional Rectangular Facing Kits



Rectangular Facing Kit in Painted Black Finish



Brown Finish



Taupe Finish



Diamond Dust Pewter Finish

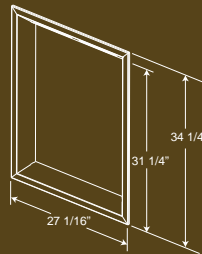
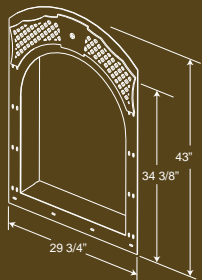

## Decorative Panels



Fluted Refractory Bricks in Sandstone Finish



Fluted Refractory Bricks with Napoleon<sup>®</sup> insignia in Sandstone Finish



Sandstone Herringbone Decorative Brick



**MIRRO-FLAME™** Porcelain Reflective Radiant Panels



Traditional Painted Black Andirons

## Andirons



Obelisk Painted Black Andirons



# The Park Avenue™ GD82T-PA

*Tall, slender, European design*



Modulating thermostatic remote control included

Shown with Sandstone Herringbone decorative brick panels, arched facing kit with Heritage pattern and traditional painted black andirons.

This tall, dark, handsome fireplace features a unique, clean, frameless design with advanced burner technology, creating the most realistic flames in the industry. The Park Avenue™ deluxe model is offered as a complete package including an exclusive NIGHT LIGHT™, heat circulating blower, handheld remote (controlling the flame, blower and NIGHT LIGHT™), and PHAZERAMIC™ advanced flame burner technology.













# Outstanding Features of Napoleon's Advanced Technology



Legend

-  Heat Radiating Infrared PHAZERAMIC™ Burner System
-  Heat Circulating Blower
-  Radiant Heat
-  Full Function Digital Remote
-  No Electricity Required to Light or Operate
-  Money Saving
-  Built-in NIGHT LIGHT™
-  Zone Heating
-  Napoleon® Exclusive Feature

## PHAZERAMIC™ Burner System

Napoleon's sophisticated PHAZERAMIC™ infrared burner system offers superior flame technology. Strategically placed burner ports combined with realistic log sets create the most realistic flames in the industry.



## Finely Tuned Precision Valves

Surrounded with a protective cast aluminum jacket, the precision valves allow for ultimate reliability and 100% SAFE GUARD™ gas control system.





### True Masonry Details

Napoleon's ceramic brick panels with true masonry texture and mortar details, help transfer additional heat, radiating out from the firebox.

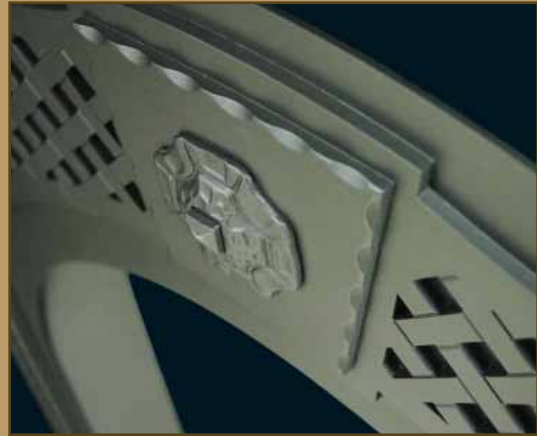

### Outstanding Craftsmanship

Distinctive hand-forged wrought iron is a hallmark of Napoleon® artisans. Fine details are designed in every aspect of Napoleon® fireplaces.

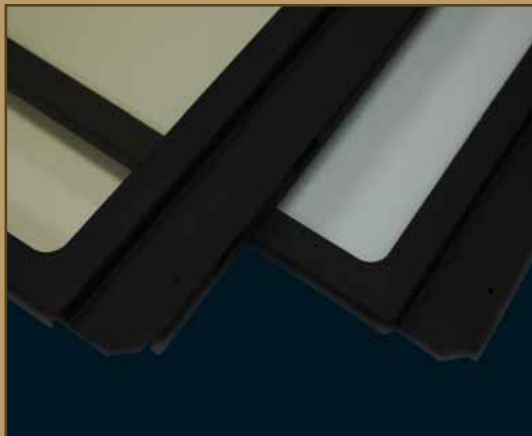

### High Heat Ceramic Glass

Ceramic glass is made to withstand extreme high temperatures, allowing maximum radiant heat performance & safety.



### WHISPER QUIET™ Heat Circulating Blower System

The extreme heat resistant "H" class bearings featured in Napoleon's superior heat circulating blower, creates a lasting "whole home" comfort with adjustable high & low speeds.



### Solid Hinged Doors

Manufactured with heavy gauge steel, the doors are conveniently hinged or pivoted for easy opening access with two snap clips.

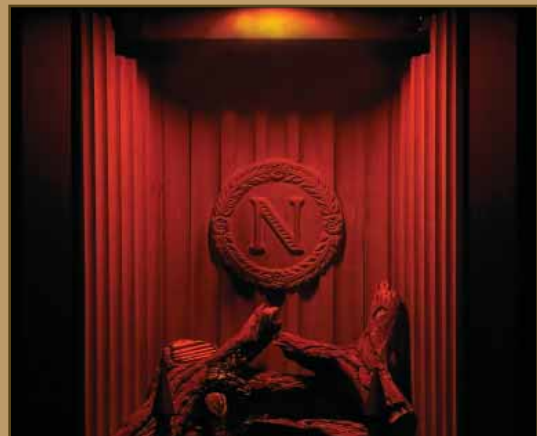

### Exclusive NIGHT LIGHT™

The exclusive NIGHT LIGHT™ illuminates the whole decorative firebox, including the logs, even when the fireplace is turned off.

# Napoleon's Direct Vent Technology

## Convenient, Clean, Reliable Heating Source

With over 30 years of research and development, Napoleon® Fireplaces have perfected direct vent technology to offer you a fireplace, stove or insert that easily fits into your lifestyle.

With Napoleon's direct vent technology, you can design and install your fireplace in unique locations where it wasn't possible before with traditional masonry fireplaces. Even your basement can be transformed into a warm, inviting oasis for your family and friends to enjoy.

Whether you are renovating, building or replacing an inefficient fireplace product, Napoleon® helps guide you in the right direction to find the product that's right for you and your home. Napoleon® Fireplaces are a smart investment that will bring many years of affordable luxury to you and your family.

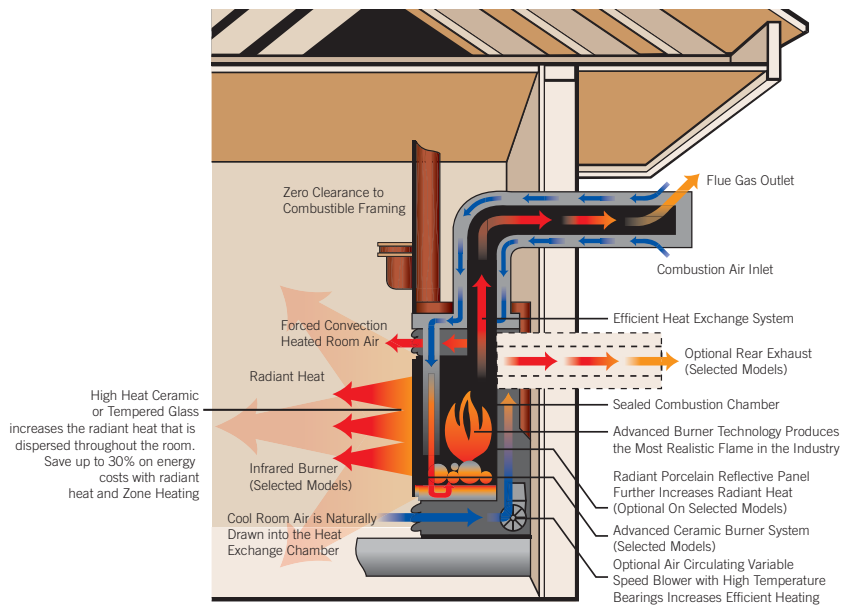

100% SAFE GUARD™ gas control system automatically and quickly shuts off the gas supply for your peace of mind.



Napoleon's Environmentally Friendly Products are designed to provide a clean burning, convenient natural gas or propane energy source - indoors and out.



Zone heating means you are heating the room that you use the most with an alternate heat source, like a Napoleon® Fireplace. Zone Heating is the obvious solution for those families concerned about rising fuel costs.

## Direct Vent Power Venting System

### Freedom and Versatility

Napoleon's new power venting system allows more freedom and versatility for direct vent installations. The option of having the termination above or below the fireplace, along with the ability to "snake" either up or down, allows installation when the desired fireplace location is a great distance away from an outside wall. The blower that pulls the burned gases from the fireplace is mounted outside at the terminal which provides WHISPER QUIET™ operation inside the home.

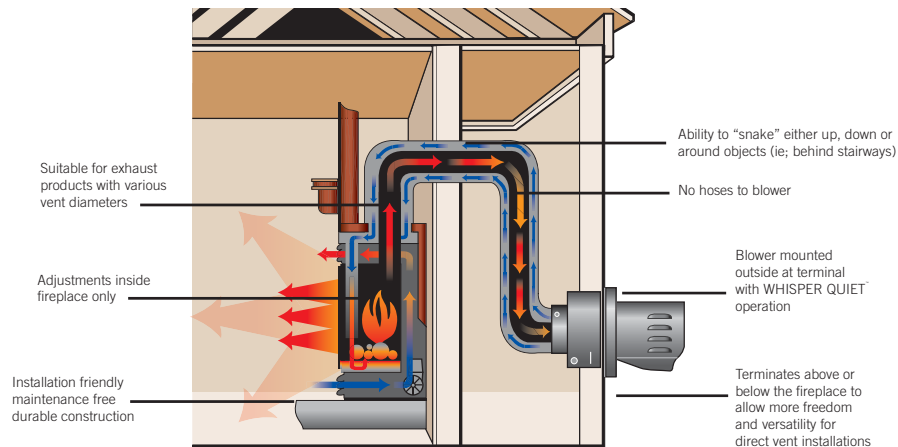

## Heating Flexibility

### Hot Air Distribution Kit

With the hot air distribution kit and its independent fan control, you are offered a choice of distributing a portion of the heat generated from your fireplace to other rooms, adding to your overall home comfort...

OR

when fireplace heating efficiency is secondary to the ambiance of a fire, disperse it outdoors... ideal for entertaining.

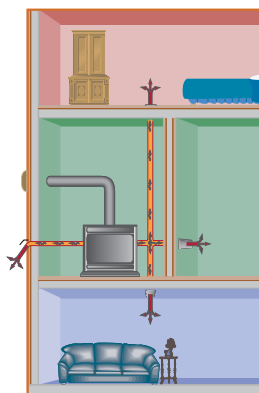

### Thermostat For Hot Air Distribution Kit

Optional thermostatic control maintains adjacent room temperature for even greater convenience.



### Blower

When you want to extract maximum heat, an optional heat circulating blower offers increased heating efficiency throughout the room.

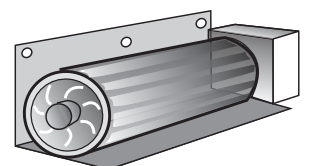



# Fireplace Features & Accessories

<b>Prestige® Collection</b>	BCD90	HD81	GD80	HDX40	GD70	GD82T-PA
Louvres (available in painted black, polished brass finish, brushed stainless steel finish and antique brass finish)	-	-	-	-	0	-
Heritage Ornamental Insets**	-	-	-	-	0	-
Bay Front	-	-	-	-	0	-
Bay Louvres (available in painted black, polished brass finish and brushed stainless steel finish)	-	-	-	-	0	-
Burner Accent Trim (polished chrome)	-	0	-	-	-	-
Bevelled trim kit (available in painted black and brushed stainless steel)	-	0*	-	0	-	-
3" Bevelled Trim (available in painted black, antique brass finish, polished brass finish and brushed stainless steel finish)	-	-	-	-	0	-
6" Bevelled Trim (available in painted black, antique brass finish, polished brass finish and brushed stainless steel finish)	-	-	-	-	0	-
Four-sided frames available in painted black, brown and diamond dust pewter	-	-	-	0	-	-
Arched Facing Kit	-	-	0	-	-	0
Arched Facing Kit with Heritage pattern in painted black finish	-	-	-	-	-	0
Arched Facing Kit in hand-forged wrought iron	-	-	-	-	-	0
Rectangular Facing Kit	-	-	0	-	-	0
Faceplate/Door Kit	0	-	0	0	0	-
Stainless Steel Surround and Hearth	-	-	-	-	-	0
Safety Screen	S	-	S	-	-	-
Decorative Doors	0	-	0	0	0	-
Cast Iron Surround Kit	-	-	-	-	0	-
Ribbed Porcelain Reflective Radiant Panels	-	-	-	0	-	-
Porcelain Reflective Radiant Panels	-	0	0	0	0	0
Newport™ Deluxe Decorative Brick Panels	-	-	-	0	-	-
Old Town Red™ Brick Panels	-	-	0	-	0	-
Sandstone Herringbone Brick Panels	0	-	0	-	0	0
Mayan Dessert Sandstone Brick Panels	-	-	-	0	-	-
Sandstone Decorative Brick Panels	-	0	0	0	0	-
Fluted Refractory Bricks with or without Napoleon® Insignia	-	-	-	-	-	0
Country Crane and Hearth Pot	0	-	-	-	-	-
Traditional Andirons - Available in painted black and 24 Karat gold plated	S*	-	S*	0*	0	0*
Obelisk Andirons - Available in painted black	-	-	-	-	-	0
Electronic Ignition	-	S	-	S	0	-
On/off Remote	-	-	-	0	0	-
Thermostatic Remote - Controls flame, blower and NIGHT LIGHT™	S	S	S	0	0	S
NIGHT LIGHT™	S	S	S	S	S	S

- = Not Available 0= Optional S= Standard \* Painted black only \*\*Available in painted black, 24 Karat gold plated & brushed stainless steel finishes

Consult your owner's manual for complete and up-to-date installation instructions and proper clearances to combustible materials. Check all local and national building codes and gas regulations. All specifications are subject to change without prior notice due to on-going product improvements. Products may not be exactly as shown. Napoleon is a registered trademark of Wolf Steel Ltd. © Wolf Steel Ltd. **EnerGuide** - A Canadian efficiency standard based on frequent, short start-up and cool-down cycles. All appliances sold in Canada are subject to this EnerGuide rating system. **AFUE** - A US efficiency standard (Department of Energy) based on extended on/off cycles, more typical of fireplace usage. **Steady State** - Reflects the highest possible overall heating efficiency.

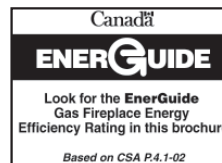

• 103 Miller Drive, Crittenden, Kentucky, USA 41030  
• 24 Napoleon Road, Barrie, Ontario, Canada L4M 0G8

Tel: 705-721-1212 Fax: 705-722-6031  
napoleonfireplaces.com





**QUALITY FIREPLACES**  
[napoleonfireplaces.com](http://napoleonfireplaces.com)

Printed in Canada ADBR900 05/2011